



Photovoltaic solar cells: An overview of state-of-the-art cell development and environmental issues

R.W. Miles*, K.M. Hynes, I. Forbes

Northumbria Photovoltaics Applications Centre, University of Northumbria, School of Engineering, Ellison Place, Newcastle upon Tyne, Newcastle NE1 8ST, UK

Abstract

This paper gives an overview of the materials and methods used for fabricating photovoltaic solar cell devices. The technologies discussed include those based on the use of silicon (in the crystalline, multicrystalline, amorphous and micro-crystalline forms), the III–V compounds (e.g. gallium arsenide, indium phosphide and gallium antimonide), the polycrystalline compounds (e.g. cadmium telluride, copper gallium indium diselenide and copper indium disulphide), and organic materials (e.g. dyes, polymers and fullerenes). The paper also discusses the important environmental and energy issues with regard to the manufacture, use and disposal of the solar cells and modules.

© 2005 Elsevier Ltd. All rights reserved.

PACS: 84.60.Jt; 81.05.Cy; 81.05.Ea; 81.05.Dz; 81.15.Gh; 81.15.Kk

Keywords: A1 environmental studies; A3 Chemical vapor deposition processes; A3 Vapor phase Epitaxy; B3 III-V solar cells; B3 II-VI solar cells; B3 organic solar cells

1. Introduction

The photovoltaic effect is the direct conversion of incident light into electricity by a pn (or p–i–n) semiconductor junction device. Although the phenomenon was known for almost a century, the landmark achievement generally accepted to have heralded the modern era of PV power generation was the production in 1954 of a 6% crystalline silicon solar cell by

* Corresponding author. Tel.: +44 191 2274594; fax: +44 191 2273650.

E-mail address: robert.miles@unn.ac.uk (R.W. Miles).

Chapin et al. [1]. It was rapidly realised that such solar cells were a convenient way of generating power in remote locations e.g. for powering communications equipment or weather monitoring stations and ideal for supplying power for the satellites and vehicles being developed for the rapidly expanding space industry. The technology has now also been deployed for a wide range of applications including supplying power for consumer products e.g. electronic calculators and garden lights, and for supplying power in developing countries e.g. for water pumping and street lighting [2]. Most PV products are now deployed in the large-scale power generation market. The cells are connected together in modules and the modules are connected to form either centralised power stations or used as part of built structures (BIPV, building integrated photovoltaics). BIPV is particularly promising as it offsets production costs, minimises land use and can significantly enhance the appearance of a building.

The principles of operation of solar cells are discussed in detail in the literature [2,3]. Photons with energies greater than the energy bandgap of the semiconductor are absorbed, promoting electrons from the valence band to conduction band, leaving a corresponding number of holes in the valence band. If the electron–hole pairs are generated within the depletion region of the pn junction (or within a minority carrier diffusion length from the edge of each depletion region) the electric field present in the depletion region separates them and drives them through an external load. Maximum power is delivered to the load when its impedance matches that of illuminated device. The solar conversion efficiency η is given by:

$$\eta = V_{OC}I_{SC}FF/P$$

where V_{OC} is the open circuit voltage (the voltage generated when the load resistance is infinite), I_{SC} is the short circuit current (the current generated when the load resistance is zero) and FF is the fill-factor (defined to be the ratio of the maximum power generated by the cell divided by $V_{OC}I_{SC}$). For comparison purposes the cell is usually illuminated with a simulated air mass (AM) spectrum, AM0 for space applications and AM1.5 for terrestrial applications. The AM0 spectrum is that incident from the sun just outside the Earth's atmosphere. The AM1.5 spectrum is the global average incident at the surface of the Earth. It is the spectrum incident at the surface of the Earth when the path length through the Earth's atmosphere/height of the atmosphere, $\sec \theta = 1.5$. θ is the angle between the elevation of the sun and the azimuth. The power of radiation incident P is 1367 W m^{-2} for the AM0 spectrum and 963 W m^{-2} for the AM1.5 spectrum.

If g_{opt} is the number of electron–hole pairs generated per unit volume per second it follows that the current generated I_{SC} is given by:

$$I_{SC} = g_{opt}eA[w + L_n + L_p]$$

where $A[w + L_n + L_p]$ is the generation volume (A is the cross-sectional area, w is the depletion region width and L_n and L_p are the minority carrier diffusion lengths in the p and n sides, respectively). Bigger the value of I_{SC} , smaller is the energy bandgap of semiconductor used to absorb the light because a larger proportion of the spectrum incident from the sun will be absorbed. The generation volume increases with a decrease of doping on each side of the device because w , L_n and L_p all increase with a decrease in doping concentration.

For an ideal solar cell:

$$V_{OC} = [kT/e] \ln [I_{SC}/I_0]$$

where I_0 is the reverse saturation current for an ideal solar cell and:

$$I_0 \propto \exp[-E_g/kT]$$

It follows that V_{OC} increases as the energy bandgap of the semiconductor used to absorb the light is increased.

The fill-factor FF and I_{SC} are found to reduce rapidly with a modest increase in the series resistance of the solar cell. In fact a series resistance of only 5Ω will reduce the device efficiency to less than 30% of what it would have been for zero series resistance [4]. The series resistance mainly arises from the bulk resistances of the n- and p-type sides of the device and the resistances of the contacts to the doped regions. Increasing the doping concentration reduces the bulk resistance of a semiconductor; it also lowers the specific contact resistance of the metal contact to the semiconductor by increasing the probability of quantum mechanical tunnelling through the metal–semiconductor junction.

Because the efficiency depends on the product $V_{OC}I_{SC}$ there is an optimum energy bandgap for producing maximum efficiency devices. A detailed analysis shows that for terrestrial power generation (AM1.5 spectrum) the optimum energy bandgap is 1.5 eV i.e. close to the energy bandgaps of the compound semiconductors, cadmium telluride (CdTe), indium phosphide (InP), gallium arsenide (GaAs), and copper indium disulphide (CuInS₂) [5,2,3]. In practice semiconductors with energy bandgaps in the range 1.0–1.7 eV are used [6]. These include monocrystalline and multicrystalline silicon (Si, $E_g = 1.12$ eV), copper indium diselenide (CuInSe₂, $E_g = 1.05$ eV), and amorphous silicon (α Si:H, $E_g = 1.7$ eV). Table 1 summarises the highest efficiencies achieved using the different semiconductor materials [7]. The silicon based devices are usually “homojunctions” i.e. junctions within the same material, whereas many of the compound semiconductor devices are “heterojunctions” i.e. junctions between dissimilar materials. These usually use an n-type wide energy bandgap “buffer layer” e.g. CdS to form a junction with the p-type absorber layer. This structure is usually preferred because the

Table 1
Best efficiencies reported for the different types of solar cell

Cell type	Highest reported efficiency for small area cells produced in the laboratory	Highest reported module efficiency
c-Si (crystalline Si)	24.7% (UNSW, PERL)	22.7% (UNSW/Gochermann)
Multi-c-Si	20.3% (FhG-ISE)	15.3% (Sandia/HEM)
α Si:H, amorphous Si	10.1% (Kaneka), N.B. single junction	Triple junction. Stabilized efficiency = 10.4%
μ c-Si/ α Si:H (micro-morph cell)	11.7% (Kaneka), N.B. minimodule	11.7% (Kaneka), N.B. minimodule
HIT cell	21% (Sanyo)	18.4% (Sanyo)
GaAs cell	25.1% (Kopin)	Not relevant
InP cell	21.9% (Spire)	Not relevant
GaInP/GaAs/Ge multijunction	32% (Spectolab), N.B. 37.3% under concentration	Not relevant
CdTe	16.5% (NREL)	10.7% (BP Solarex)
CIGS	19.5% (NREL)	13.4% (Showa Shell), N.B. for copper gallium indium sulphur selenide
Dye sensitised cell	8.2% (ECN)	4.7% sub-module (INAP)

N.B. This data was taken from Ref. [7].

minority diffusion length of electrons in a p-type semiconductor is much greater than that of holes in an n-type semiconductor.

The purpose of this paper is to give an overview of the main methods of production of photovoltaic solar cells, and to give a critical appraisal of the environmental and energy related issues associated with each technology.

2. Silicon solar cells

2.1. Monocrystalline silicon

Silicon has an indirect energy bandgap of approximately 1.1 eV at room temperature. The indirect energy bandgap results in a low optical absorption coefficient, $\alpha \approx 100 \text{ cm}^{-1}$ and this means that the silicon needs to be several hundred microns thick ($\gg 1/\alpha$) to absorb most of the incident light. The electron–hole pairs generated by the light should be able to diffuse up to that distance to reach the electric field in the depletion region of the junction if they are to contribute to the photocurrent. (Increasing w to more than a few microns by lowering the doping concentrations is at the expense of increasing the device series resistance to the point where it severely degrades device efficiency.) The ability of the carriers to diffuse to the junction region is measured by the minority carrier diffusion length, L . Elementary semiconductor theory shows that:

$$L \propto \sqrt{\mu\tau}$$

where μ is the mobility and τ is the lifetime of minority carriers in the light absorbing region [7]. As both μ and τ are very sensitive to material purity and crystallinity efficient devices can only be produced if the feedstock is pure enough and the densities of crystal defects minimised. In practice it is found that the purity needed to make cells (“solar grade silicon”) is less stringent than that needed for the microelectronic industry and in fact most PV cells manufactured to date use silicon supplied by the larger microelectronics industry. The rapid expansion of PV sales over the past 5 years means that manufacturers are now considering purifying silicon themselves for use in producing PV solar cells [8].

A cross-sectional view of the conventional silicon solar cell structure that has dominated production up to the present is given in Fig. 1 [8]. The boron doped p-type monocrystalline silicon wafer is sawn from a boule of silicon grown using the Czochralski method and the pn junction

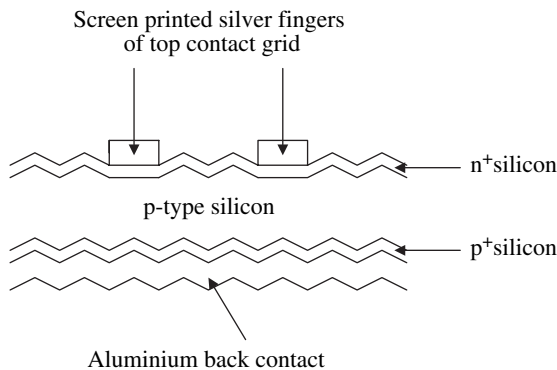

Fig. 1. Schematic cross-sectional view of a silicon solar cell with screen printed contacts.

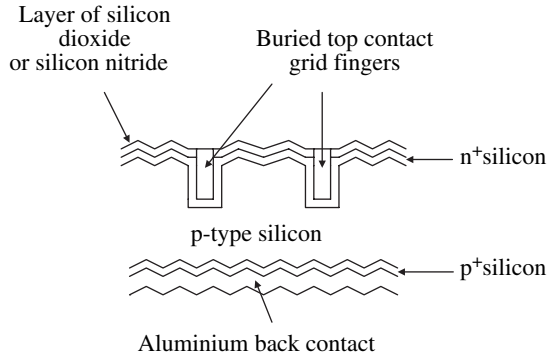

Fig. 2. Schematic cross-sectional view of an UNSW solar cell with buried contacts.

formed by diffusing phosphorus impurities into the wafer. Screen printed silver contact fingers are used on the n -type surface to make both electrical contact and to allow light to be transmitted to the junction region [9]. Aluminium paste is used to make contact at the back p -type surface. This is annealed to introduce a p^+ doped region at the back of the cell, to lower the contact resistance and to supply a back surface field that reflects minority carriers back towards the junction [10]. The cell surface is textured to minimise reflection and to refract light to high angles of refraction to enhance the path length of the light within the silicon. An antireflection coating (usually titanium dioxide) is deposited over the top contact fingers to complete the device.

Green and co-workers from the University of New South Wales (UNSW) have pointed out that there is a high penalty for using screen printed contacts [11]. High shading losses, the high resistivity of the screen printed silver grids compared to pure silver ($3\times$ as high), a high contact resistance between the grid and silicon and poor aspect ratio all reduce device efficiencies to approximately 14%. This has led them to develop solar cells in which the contacts are defined either using photolithography or laser scribing [12]. A typical “UNSW cell structure” is shown in Fig. 2. For the design shown the surface of the silicon has been oxidised to passivate the front surface of the cell and grooves for contacting cut using laser scribing. In this buried contact design the contact metals, nickel, copper and then silver, are deposited using electroless methods. The improved design permits shallower phosphorus doping at the surface of the device without degrading the open circuit voltage, improving the short wavelength response of the

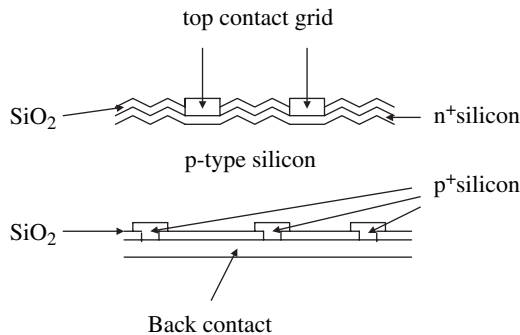

Fig. 3. Schematic cross-sectional view of a PERL (“passivated emitter rear locally diffused”) solar cell.

cell. The higher doping concentration of this n+ region also reduces the contact resistance to the grid contact. This type of cell is used in the high efficiency PV modules produced by a range of companies including the Saturn modules sold by BP Solar.

A more advanced design is that of the PERL (“passivated emitter rear locally diffused”) solar cell shown in Fig. 3. In this device the back surface of the cell is oxidised and then the p+ regions formed in localised areas of the device by opening windows in the oxide layers and then diffusing dopant impurities into these regions. The silicon dioxide passivates the back surface of the device and is also much more effective at reflecting light back into the device than the aluminium back contact and p+ regions alone. The surface is also textured to produce a topology of inverted pyramids that are very effective at refracting light to high angles of refraction. This cell design has resulted in small area devices with efficiencies > 24% and foot square modules with efficiencies > 20% which are currently the world records for crystalline silicon [13]. A slightly modified design is the PERC (passivated emitter rear floating junction) cell. This is commonly used for space applications [14].

In recent investigations of the factors limiting cell efficiency it has been found that doping silicon with boron induces a defect that leads to a light induced degradation of the minority carrier lifetime in p-type silicon and hence to a drop in efficiency of high performance cells by approximately 1–2%. One way to avoid this problem is to use gallium instead of boron to dope the Czochralski grown wafers p-type. Experiments have shown that there is no light induced degradation in cells fabricated using the Ga-doped wafers confirming that gallium is a highly promising alternative dopant to boron [21].

Crystalline silicon devices and modules have dominated production and sales from 1954 until 2000. Although the sale of silicon solar cells has continued to grow rapidly the market share of monocrystalline silicon products has actually reduced to approximately 40% of sales volume due to increased competition from devices based on the use of multicrystalline silicon. The cells sold usually have efficiencies in the range 10–16%, the more sophisticated designs resulting in the higher efficiency devices [8].

2.2. Multicrystalline silicon

With this technique molten silicon is poured into a container and then allowed to cool resulting in silicon ingots with large columnar grains (typically 0.3 mm diameter) growing from the bottom of the container upwards [15]. The grains are so large that they extend through the wafers cut from the solidified block. The incorporation of hydrogen during device processing plays an important role in passivating the grain boundaries in the devices formed. This is most conveniently introduced by using PECVD (plasma enhanced chemical vapour deposition) to deposit silicon nitride as the top insulating layer, rather than silicon dioxide, as hydrogen is used in this process. Advantages of using multicrystalline growth over the Czochralski method include lower capital costs, higher throughput, less sensitivity to the quality of the silicon feedstock used and higher packing density of cells to make a module because of the square or rectangular shape of the cells. The best modules made using multicrystalline silicon generally have efficiencies 2–3% less than those of crystalline silicon and cost approximately 80% of that of crystalline silicon cells to produce. The market share of this product (55%) has continued to increase over the past 5 years and is still increasing. Apart from reduced cost, it has pointed out that the average efficiency of commercial multicrystalline silicon modules sold (12.6%) is actually not very different from the average for commercial crystalline silicon cells sold (12.8%) probably due to the manufacturers not fully exploiting the potential of crystalline

silicon [8]. The aesthetic appearance of the multicrystalline silicon modules is also generally considered by architects to be more appealing than the crystalline silicon counterparts.

2.3. Silicon ribbon

With the EFG (“edge defined film fed growth”) method a graphite dye is immersed into molten silicon and the silicon rises into the space in the dye by capillary action; it is then possible to pull a self supporting 2-D sheet of silicon from the dye [16]. Although the method was first developed by the US firm Mobil Solar it was sold in 1994 to Angewandte Solarenergie GmbH, a subsidiary company of a major supplier of electricity in Germany.

Alternatively the “dendritic web growth process” may be used [17]. Two dendrites are placed into molten silicon and when withdrawn quickly from the melt a thin sheet of silicon is trapped between them and quickly solidifies. The latter method has more recently evolved into the “string ribbon method” in which two graphite strings are used rather than the dendrites as this makes process control much easier [18]. In all cases the silicon is multicrystalline with a quality approaching that of the directionally solidified material. Solar modules made using silicon sheets produced with these methods generally have efficiencies in the range 10–12%.

Despite initial optimism that silicon ribbon technologies would dominate production and sales, the market share has remained small (approximately 1% of total sales).

2.4. Amorphous silicon

Thin films of amorphous silicon are produced using the CVD (chemical vapour deposition) of gases containing silane (SiH_4), usually “PECVD” [19] or “hot wire CVD” [20]. The layers may be deposited onto both rigid substrates e.g. glass and onto flexible substrates e.g. thin metallic sheets and plastics, allowing for continuous production and diversity of use. The material that is used in solar cells is actually hydrogenated amorphous silicon, $\alpha\text{Si:H}$, an alloy of silicon and hydrogen (5–20 atomic % hydrogen), in which the hydrogen plays the important role of passivating the dangling bonds that result from the random arrangement of the silicon atoms. The hydrogenated amorphous silicon is found to have a direct optical energy bandgap of 1.7 eV and an optical absorption coefficient $\alpha > 10^5 \text{ cm}^{-1}$ for photons with energies greater than the energy bandgap. This means that only a few microns of material are needed to absorb most of the incident light, reducing materials usage and hence cost. Doping is found to severely degrade the mobility and lifetime of minority carriers in amorphous silicon. It has been found

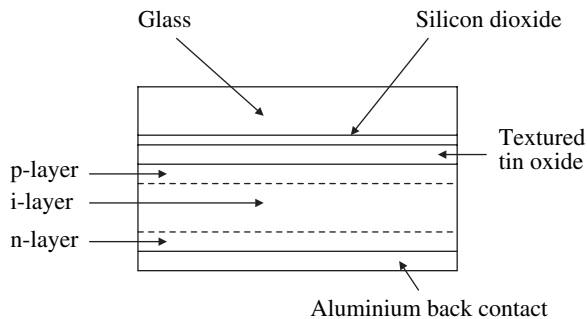

Fig. 4. Schematic cross-sectional view of an amorphous silicon single junction solar cell.

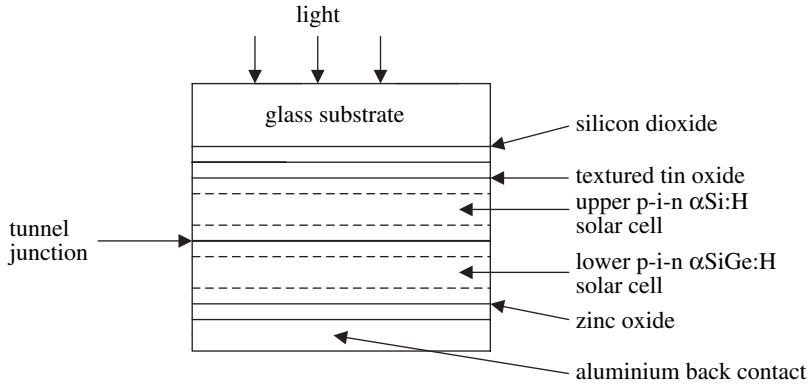

Fig. 5. Schematic cross-sectional view of an amorphous silicon double junction solar cell.

that this problem can be minimised by using a p–i–n device structure where the light is absorbed, the electron–hole pairs are generated and also move within the undoped i-layer, assisted by the electric field across it. A cross-sectional view of a typical p–i–n cell structure is shown in Fig. 4. Although the initial efficiency of the cells made in the laboratory can be $>12\%$, commercial modules when exposed to sunlight over a period of months degrade to an efficiency of approximately 4–5%. This phenomenon is known as Staebler–Wronski effect [19].

It is, however, possible to absorb the solar spectrum more efficiently and to improve cell stability by using multiple pin structures with different energy bandgap i-layers to produce “double junction” or “triple junction” structures. Narrower energy bandgap layers are produced by alloying the silicon with germanium and wider energy bandgap layers are produced by alloying the silicon with carbon. A cross-sectional schematic view of a double junction cell is shown in Fig. 5 and a triple junction cell in Fig. 6. The highest reported stabilised efficiency of a double junction is now $>9.5\%$ and for a triple junction module $>10\%$ [19]. Currently amorphous silicon modules account for less than 5% of the number sold for use in commercial systems.

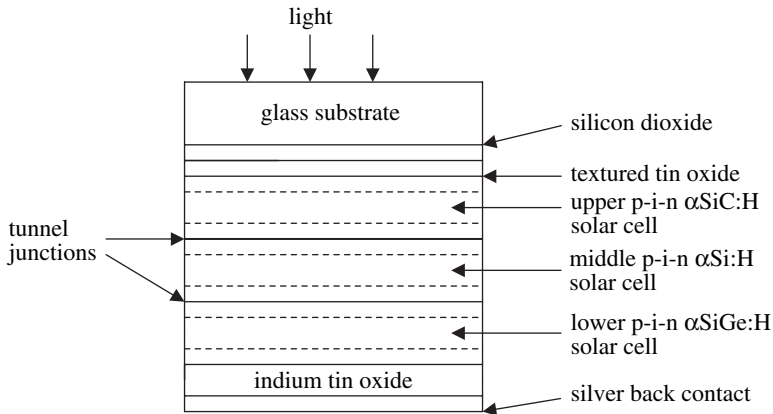

Fig. 6. Schematic cross-sectional view of an amorphous silicon triple junction solar cell.

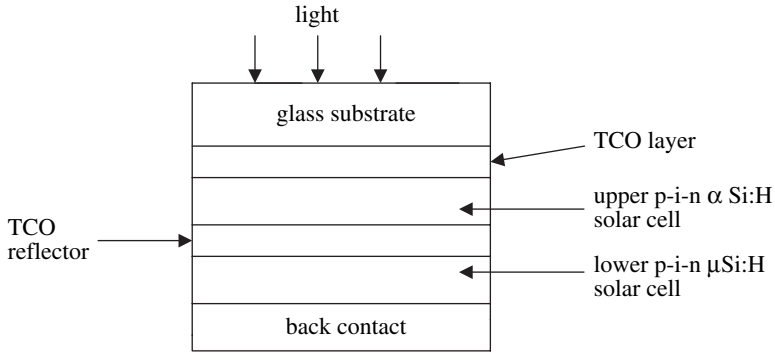

Fig. 7. Schematic cross-sectional view of a “micro-morph” solar cell.

2.5. Microcrystalline silicon

If the gases used for the deposition of amorphous silicon are diluted in hydrogen then the microstructure of the deposit varies. In particular, for highly diluted gases the deposit consists of regions of crystalline silicon immersed in an amorphous matrix [21]. This two-phase material is known as “microcrystalline silicon”. The physical properties of the material resemble those of crystalline/multicrystalline silicon rather than amorphous silicon, especially with regard to stability under intense illumination. Work is currently underway to develop hybrid amorphous-silicon/microcrystalline-silicon tandem solar cells and modules (Fig. 7). Trials indicate that these hybrid devices and modules rival triple junction amorphous silicon in terms of efficiency and stability [22].

2.6. HIT solar cell

A novel device developed by Sanyo is the HIT cell [23]. In this device layers of amorphous silicon are deposited onto both faces of a textured wafer of single crystal silicon as shown in Fig. 8.

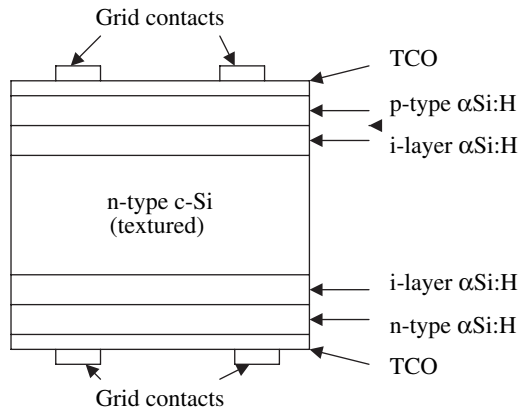

Fig. 8. Schematic cross-sectional view of the HIT solar cell produced by Sanyo. Note that the thickness of the crystalline silicon substrate is 200 μm , while the total thickness of intrinsic + p-type amorphous silicon layers on the top of the substrate is 10 nm and the total thickness of the intrinsic + n-type amorphous silicon on the underside of the substrate is 20 nm.

This results in (10 cm × 10 cm) multijunction devices with efficiencies > 21% and 80 cm × 120 cm modules with efficiencies up to 18.4%. The advantages of this structure include potential for high efficiency, very good surface passivation, low temperature processing (all steps < 200 °C, except for substrate production), reduced energy payback time and reduced cost relative to conventional silicon devices.

2.7. Other thin film silicon concepts

Reducing the thickness of silicon used is desirable to minimise materials usage and alleviate the fear that a lack of silicon feedstock may limit the rapid expansion of the PV market [8]. Much early work in this area has been done by the US Company, Astropower Inc. which demonstrated that “advanced light trapping techniques” can be used to produce efficient devices using multicrystalline layers as thin as 20 μm [24]. In a recent study Poortmanns et al. suggest that the limit to the thickness of silicon that could be used may be as low as 2 μm [25,26]. The thin film deposition processes being developed generally use substrate temperatures between 600 °C and 1420 °C (the melting point of silicon) and include CVD, LPE (liquid phase epitaxy) and ZMR (zone melting recrystallisation) methods. Work is underway in Europe to develop thin film silicon technologies, either epitaxially on lower quality silicon substrates or as thin films on foreign substrates e.g. ceramics [27,28].

Origin Solar Energy Pty Ltd in Adelaide, Australia, have developed a radically new way of using crystalline silicon [29]. The “sliver solar cells” they produce are formed by micromachining parallel grooves perpendicular to the surface of the silicon wafer that extend almost all the way through the slice to leave 60 μm thick “slivers” of silicon supported on the remaining substrate. After processing of the slivers into solar cell devices the remaining silicon is cut or etched to separate the cells from each other. The cells are incorporated into a novel module design that incorporates a diffuse reflector at the back. A substantial gap is left between the cells when they are included in the module such that light passing through the gaps is reflected onto the back surface of the bifacial cells. Origin reports that individual cells with efficiencies > 19% have been made and modules with 50% cell coverage have resulted in efficiencies up to 12.3%. They also report a significant reduction of cell production costs and energy payback time.

3. Solar cells based on the use of III–V compounds

3.1. Single junction III–V materials and devices

III–V Compounds such as gallium arsenide (GaAs), indium phosphide (InP) and gallium antimonide (GaSb) have direct energy bandgaps, high optical absorption coefficients and good values of minority carrier lifetimes and mobilities (in highly pure, single crystal material) making them excellent materials for making high efficiency solar cells. Single crystals of these materials can be produced using either the liquid encapsulated Czochralski method or using a Bridgmann method. The two III–V materials most widely used for single junction solar cells are GaAs and InP. Solar radiation with energy above that of the bandgap is absorbed efficiently within a few micrometers of the surface because of their high absorption coefficients. Both materials have near optimum bandgap values for single-junction conversion of the solar spectrum. The bandgap of GaAs is 1.424 eV and that of InP is 1.34 eV. InP has a minority carrier diffusion length, L_n (for Zn doped p-InP wafers) in the range 2–30 μm depending on doping density.

One of the first GaAs based solar cells with a reasonably high efficiency was a pn junction device with an AM1 efficiency of 11% [30]. The first AlGaAs/n-GaAs device was reported by Alferov et al. [31]. The first InP solar cells were homojunction devices produced by thermal diffusion [32]; however, subsequently a range of device structures was produced using a range of different techniques. The first high-efficiency InP based devices were produced during the second half of the 1970s [33]. The historical development of single junction InP based devices was reviewed in the 1989 [34].

It should be noted that efficiency values quoted depend on the conditions under which they are measured. For instance, early terrestrial cells tended to be measured under an AM1 spectrum, whereas the current standard spectrum is AM1.5 at 1000 W m^{-2} and 25°C . The standard for space measurements is the AM0 spectrum (the solar spectrum, at the Earth–Sun distance, without atmospheric absorption). The confirmed values quoted in the efficiency tables are those measured under the relevant standard conditions and usually confirmed by at least one additional recognised and independent test centre (see Ref. [7]). Therefore, when comparing values it is important to compare measurements made under the same conditions or understand the implications of differences in those conditions.

The disadvantage of using III–V compounds in photovoltaic devices is the very high cost of producing device quality substrates or epitaxial layers of these compounds. Crystal imperfections, including unwanted impurities, severely reduce device efficiencies and alternative lower cost deposition methods cannot be used. These materials are also easily cleaved and are significantly weaker, mechanically, than Si. The high density of the materials is also a disadvantage, in terms of weight, unless very thin cells can be produced to take advantage of their high absorption coefficients. These drawbacks led to them being considered as unpromising materials for single junction, terrestrial, solar cells. It was primarily due to their potential for space applications that development of III–V based devices was undertaken. The potential for high conversion efficiencies together with radiation resistance in the demanding environment of space power generation mitigated against the high materials cost.

The success of Si solar cells for generating electrical power in space led to a demand for higher performance devices and in the maintenance of performance during operation. An important factor that needed to be addressed was the degradation in performance due to radiation damage from high energy electrons and protons. Reducing degradation reduces the weight at launch. Radiation damage to the materials is most severe at the depth where the radiation stops giving up the energy to the crystal lattice, i.e. at the end of the range of the charged particle. The damage to the lattice results in the creation of recombination centres and loss of cell performance. Depending on the environment the energy of the radiation varies and thus the stopping depth varies. As an indirect bandgap semiconductor Si requires a greater volume to absorb the convertible solar radiation and this volume makes it more susceptible to radiation damage. For a given application, it is the end of life (EOL) performance that determines the size of the beginning-of-life (BOL) array size. Direct bandgap, high performance cells based on III–V materials can be made significantly thinner than Si based devices. Most of the protons and electrons pass through the thin active region and cause minimal lattice damage. The development of the GaAs based cells and their testing in space flights and in radiation trials confirmed the benefits of using these devices for space power generation. Weinberg et al. [35] concluded that n/p GaAs homojunction cells were superior both in radiation resistance and efficiency to conventional Si n/p devices. It was also found that InP based devices gave high performances and resistance to radiation damage. InP based devices were shown to have a superior radiation resistance to GaAs devices [36–38] and this was attributed to the electronic annealing

enhancement of major defect centres. Annealing of defects produced from 1 MeV electrons, by both current injection (by either forward biasing the cell or by illuminating the cell) and thermally, resulted in improved post irradiation performance [39]. Space flight experiments confirmed the radiation resistance of InP based solar cells compared to both Si and GaAs based devices. The superior radiation resistance was demonstrated for ITO/InP and n/p homojunction cells during the first space flight test of InP devices on the LIPS III satellite [40,41] and in 1990, 1300 diffused homojunction InP cells, produced by Nippon Mining Company Ltd, with average efficiencies of 16.5% were installed on the MUSES-A Lunar Orbiter [42]. The confirmed highest GaAs and InP single junction terrestrial (AM1.5) conversion efficiencies are 25.1 and 21.9% for epitaxially grown homojunction cells produced by the Kopin and Spire corporations, respectively, in the US [43].

The density of GaAs, at 300 K, is 5.32 g cm^{-3} and that of InP is 4.79 g cm^{-3} , more than twice that of Si (2.33 g cm^{-3}). The high density and relative fragility of both InP and GaAs compared to Si and the need to minimise weight and cost and to increase strength led to the conclusion that these devices would ultimately need to be grown on alternative substrates, with Si being the most studied candidate. It was recognised early in the development of InP based devices that the cost of the substrate accounted for over 90% of the cell cost and that this would need to be significantly reduced in order for InP cells to be able to compete with Si and GaAs based devices. To overcome this, efforts were made to reduce the amount of InP by growing thin layers on lower cost and lighter substrates or by use of high efficiency concentrator cells [44]. However, the large lattice mismatch has remained a major obstacle. Small ($<0.2 \text{ cm}^2$) single junction concentrator devices of GaAs grown on Si substrates and InP devices on GaAs substrates have reached efficiencies of 21.3 and 21.0%, by Spire and the National Renewable Energy Laboratory (NREL) in the US, respectively.

The best single junction GaAs and InP based devices were grown by epitaxial techniques using liquid phase epitaxy (LPE) and metalorganic chemical vapour deposition (MOCVD) processing. Compared to diffusion based technology this is a high cost processing route but it enables close control over the growth parameters. The addition of an additional and expensive process to grow the high quality epitaxial layers increases the cost per Watt. The increase in device efficiency over that of non-epitaxial cells must be greater than the additional processing cost if the devices are to be produced economically. The additional cost of growing monolithic multijunctions compared to a single epitaxial junction is relatively small and the potential for increasing device efficiency is much greater. Therefore, over the last 15 years the major effort on III–V based devices has been on multijunction devices and the record single junction solar cell efficiencies have remained unchanged since the early 1990s. Most work on III–V single junction devices has been on structures that are intended as sub-cells within multijunction cells. Single-junction, low bandgap, gallium antimonide (GaSb) and indium gallium arsenide (InGaAs) based devices have been used for thermophotovoltaic applications.

3.2. III–V Multijunction devices

A single junction device is able to convert solar radiation with energy above the bandgap value of the absorber material. However, as the photon energy increases, the energy in excess of the bandgap does not generate electron–hole pairs, but is lost to the lattice as heat which limits the efficiency of the cell. It has been shown theoretically that, by increasing the number of junctions with a range of different bandgap values tailored to the range of photon energies available in the solar spectrum, it is possible to significantly increase the conversion efficiency. There was

an early report of the concept of multijunction (MJ) devices in the 1950s [45]. However, it was the work of Loferski [46,47] that indicated a maximum theoretical efficiency of $\sim 60\%$ by stacking N component cells. Henry gave an efficiency of $\sim 72\%$ for an MJ cell with 32 bandgaps [48].

The bandgap values selected for the MJ depend on the number of junctions used. Several concepts for MJ cells have been investigated and they include optically splitting the spectrum into bands that correspond to the bandgaps of discrete cells, mechanically stacking discrete cells on top of one another and growing, monolithically, the cells in a stack where they are physically, electrically and optically connected. For both the mechanically and monolithically stacked cells the incident light must pass through the stack from highest bandgap sub-cell to the lowest, they are sometimes called cascade cells. However, work has continued on mechanically stacked devices which also yield high efficiencies. Mechanically stacked devices (denoted by the “//” between materials) offer greater flexibility in terms of the sub-cells and electrical connections that can be used. For instance, completely incompatible materials can be used to produce efficient devices. An example is the GaAs/CuInSe₂ cell (Fig. 9) developed by Boeing during the 1980s [49,50]. For many years the highest efficiency device was a gallium arsenide upper cell in tandem with a gallium antimonide solar cell below GaAs//GaSb (1.42 eV//0.72 eV, efficiency $> 30\%$) [51]. Although the use of discrete cells is attractive because of the freedom of design and choice of cells, in practice the technological difficulties of maintaining the optical arrangement and electrical connections to the individual cells made it advantageous to follow the monolithic approach. This structure has received the most attention and this route has yielded the highest efficiency MJ cells.

It should be noted that efficiency values quoted for MJ devices can be for significantly different measurement conditions and care needs to be taken when comparisons are made. In addition to the terrestrial (AM1.5) and space (AM0) spectra, the devices may have been measured under non-standard spectral or concentration ratios. The latter can vary from several hundred times 1 suns (~ 200 suns) to over 1000 suns.

Two essential requirements for monolithic devices are a suitable materials system that enables the growth of efficient sub cells on top of one another and that the current produced by

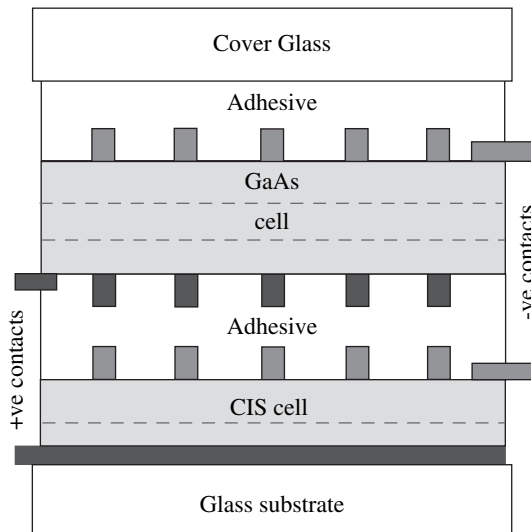

Fig. 9. Schematic cross-sectional view of a mechanically stacked GaAs//CIS cell.

each should be matched since they are connected in series. The most successful materials currently used for MJ cells are the ternary III–V alloys based on the GaAs and InP materials systems. However, as the number of cells increases the complexity of the device also increases and until relatively recently most MJ devices were either two or three junction cells (tandem or triple junction). The difficulties arise because there are several requirements for MJ devices to operate. Materials with suitably different bandgap values must be available and the optical characteristics of the cell must be such that the light not absorbed by one cell must be available to the next cell, so requiring interfaces between cells that are transparent to the appropriate wavelengths. However, the device must also be designed to enable electrical connections to be made to the device and between sub-cells.

Epitaxially grown, high quality, single crystal layers have produced high performance devices. However, initially the growth technique used was LPE which was limited to production of single junction devices because of the difficulty in growing multi-component systems using this technique. With the development of metalorganic vapour phase epitaxy (MOVPE), also known as MOCVD, and its application to the production of GaAs based space cells, the foundation of monolithically grown MJs was laid. By selection of a suitable materials system, it was possible to grow monolithic device structures that achieve high efficiencies and are more easily integrated into an array. It is possible to grow complex device structures because a number of different III–V materials compositions can be grown epitaxially and sequentially and doped to produce high quality single crystal devices with different bandgaps. The development of the GaInP₂/GaAs materials system in the 1980s and the invention of the first two-junction (cascade) cell at NREL in 1984 was a key development in III–V monolithic MJ research. This latter work later yielded a high performance (21.8% AM1.5) GaInP₂/GaAs, 2 junction, device [52]. By 1990 the efficiency had reached 27.3% (Fig. 10) and provided a path to develop triple junction devices (GaInP/GaAs/Ge) (~1.9 eV/1.42 eV/0.67 eV) with the GaInP₂/GaAs grown on a diffused Ge junction. The current confirmed highest efficiency device is a GaInP/GaAs/GaInAs triple junction device at 37.9% made by National Renewable

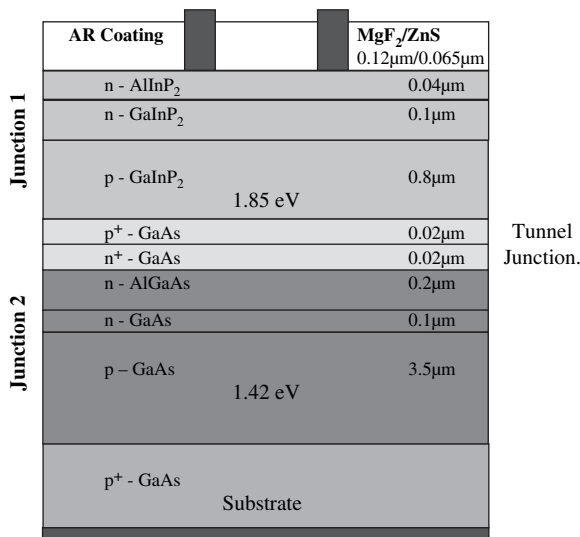

Fig. 10. Schematic cross-sectional view of the 27.3% (AM1.5G) monolithic GaInP₂/GaAs tandem cell grown on a GaAs substrate.

Energy Laboratory (NREL) in the US. The previous world record was a 37.3% GaInP/GaAs/Ge device produced by Spectrolab. Both devices were of small area $< 0.3 \text{ cm}^2$ and were measured under a low aerosol density direct beam spectrum and under concentration (10 suns and 175 suns, respectively) [43].

Spectrolab is the largest producer of commercial MJ devices and their latest triple junction cells, Ultra Triple Junction (UTJ) solar cells, these have typical BOL cell efficiencies AM0 (135.3 mW cm^{-2} , $28 \text{ }^\circ\text{C}$) at load voltage of 28.3% with minimum EOL efficiencies at maximum power of 24.3% for 32 cm^2 commercial devices. Yoon et al. [53] described recent advances in the UTJ III–V MJ space cells at Spectrolab Inc. The company also makes commercial dual junction cells and has produced over 800 kW of MJ devices with over 225 kW on orbit and claims the ability to produce nearly 1 MW of cells per year. Emcore is the other main US manufacturer of MJ devices and has produced over 400,000 solar cells. The commercial MJ devices they produce are the advanced triple junction (ATJ) and triple junction devices. Typical conversion efficiencies of these are 27.6% average lot efficiency (AM0, $28 \text{ }^\circ\text{C}$) for cell areas of $>26 \text{ cm}^2$ [54]. The standard triple junction has an InGaP/GaAs/Ge structure whereas the ATJ has an InGaP/InGaAs/Ge structure similar to that shown in Fig. 11.

The high cost of MJ cells means that they are not competitive for terrestrial applications even with $\sim 30\%$ conversion efficiency values. However, if used to convert concentrated solar

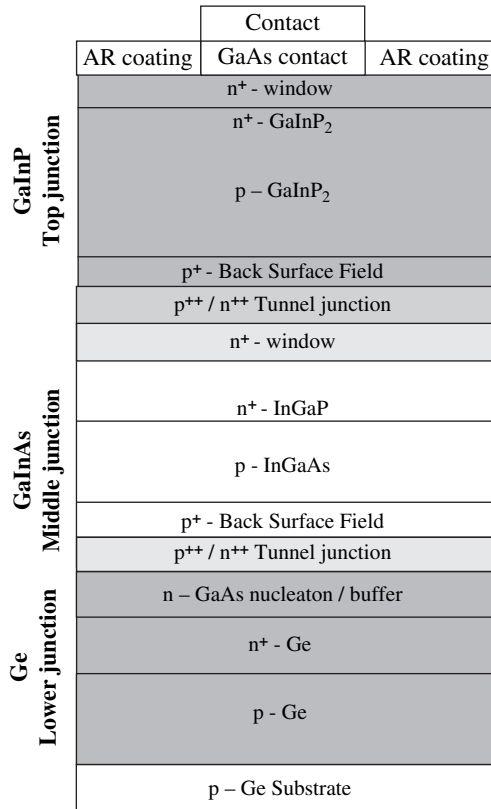

Fig. 11. Schematic cross-sectional view of a monolithically grown GaInP₂/InGaAs/Ge triple junction space cell. The GaInP₂/InGaAs epitaxial junction is grown on the “active” (diffused junction) Ge substrate.

radiation, the cost per Watt can be reduced by the concentration ratio, to between 100 and 1200 times lower. For this reason concentration systems have also seen a significant research effort and III–V MJ devices have been produced to operate under high solar concentrations. However, the requirements of working efficiently at high concentrations bring further engineering challenges. In particular the devices must be capable of operating at the correspondingly high current levels, increasing from mA cm^{-2} to A cm^{-2} . Concentrator systems require continuous direct solar radiation and the optical arrangement makes them sensitive to the position of the sun in the sky. The high cost of multijunction devices makes it necessary for them to be used in concentrator systems. In addition, MJ cells are designed to operate under a particular spectrum and if that spectrum changes the cell performance can be severely reduced. Generally, concentrator systems are not able to be as widely used as flat plate systems and therefore, terrestrial multijunction devices are likely to be limited to locations where long periods of direct sunlight are common. Suitable locations require minimal cloud cover and tracking systems to follow the Sun across the sky.

Spectrolab also produces commercial triple junction terrestrial concentrator cells with a typical 350 suns efficiency of 30.5% (10.7 W cm^{-2}) and 1000 suns efficiency of 28.6% (28.6 W cm^{-2}). The Spectrolab cells have an optimised $\text{GaInP}_2/\text{GaAs}/\text{Ge}$ structure similar to that shown in Fig. 4. Emcore in the US and Sharp in Japan also produce terrestrial MJ concentrator cells.

In response to the increasing requirements for larger space power requirements, with satellites of 30 kW being planned in the next few decades, there is an increasing demand for high power cells. A recent review of MJ devices [54] provided a summary of the activity on these devices over the last 50 years and gives some indication as to the future direction of research and development in this field from one of the major MJ manufacturers. The cautious prediction of the future for MJ devices included the introduction of a fourth junction into the $\text{GaInP}_2/\text{GaAs}/\text{Ge}$ device and the viable development of mechanically stacked cells. Also suggested is that the metamorphic or lattice mismatched approach will be used to optimise the bandgaps of the $\text{GaInP}_2/\text{GaAs}/\text{Ge}$ cell and there will be development of a new materials system. Work in the late 1990s on InGaAsN as a fourth junction identified a range of problems. However, nitride based alloys of the III–V compounds are suggested as a future materials system for an MJ device if suitable substrates can be found, the growth rate can be increased and doping issues can be resolved.

In Europe, the European Space Agency and the German Space Agency, together with the Fraunhofer ISE and RWE Space Solar Power GmbH, are working on a number of routes to achieve MJ cell efficiencies between 40 and 50% (AM0) with increased radiation resistance. The work on III–V multijunction space solar cells includes the development of $\text{GaInP}/\text{GaInAs}$ two junction concentrator cells, GaInNAs single junction (1 eV) device and three junction devices, all as part of the development of four and five junction devices and a planned six (six-tuple) device that would include a GaInNAs junction (Fig. 12). Compared to the four-junction device, if the GaInNAs junction is included in a six-junction cell it would need to generate significantly less current ($>8.5 \text{ mA cm}^{-2}$). This was predicted as achievable by the trial single junction [55]. Improvements in the three-junction devices included the use of a wider bandgap, disordered GaInP top cell (1.88 eV) in place of the ordered material (1.78 eV). The planned six-junction cell has a structure as shown in Fig. 13 [55]. A report of the first MJ cell with five active junctions used the following materials: AlGaInP , GaInP , AlGaInAs , GaInAs grown on an active Ge cell by MOVPE (see Fig. 14) [56]. This cell exhibited a V_{oc} value of 4.83 V under a three-source AM0 simulator. However, measurement of this five-junction device was

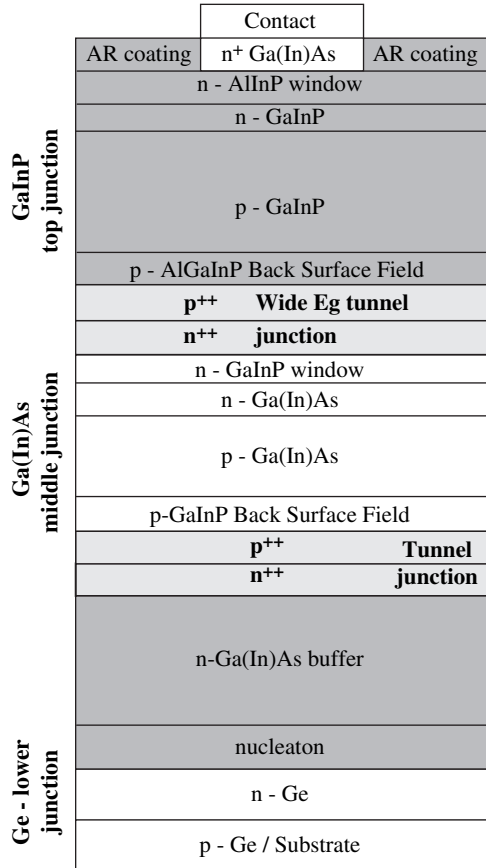

Fig. 12. Schematic cross-sectional view of a monolithically grown GaInP₂/InGaAs/Ge triple junction lattice matched concentrator cell. The n-GaInAs buffer layer is used to minimise the lattice mismatch between the diffused Ge lower junction and the active GaInAs middle junction.

challenging and a reliable value for conversion efficiency is difficult to achieve using their current simulators.

In Japan the key initiative in multijunction cell development was the Super High Efficiency Solar Cell Project which began in 1990. The aim of this project was to produce a cell with a conversion efficiency of greater than 40%. The project has included development of two- and three-junction devices and mechanically stacked (InGaP/GaAs//InGaAs, GaAs//InGaAs, GaAs//InGaAsP) and monolithic (InGaP/InGaAs, AlGaAs/GaAs, AlGaAs/Si, InGaP/GaAs/Ge) devices [57–59]. The highest efficiency mechanically stacked device was the InGaP/GaAs//InGaAs cell produced by Japan Energy, with an efficiency of 33.3% AM1.5. The highest efficiency measured for any of the cells in the project was reported as 37.4%, under 200 suns concentrated AM1.5 (global) spectrum. Other companies involved in the MJ project include Sumitomo Electric, NTT, and Hitachi Cable. An important development within this project was the use of the double heterostructure InGaP tunnel junction with AlInP barriers which increased the tunnel junction current from 5 mA cm⁻² to 2 A cm⁻² and reduced Zn diffusion [60]. The project for the development of high efficiency solar cells was taken over by Sharp,

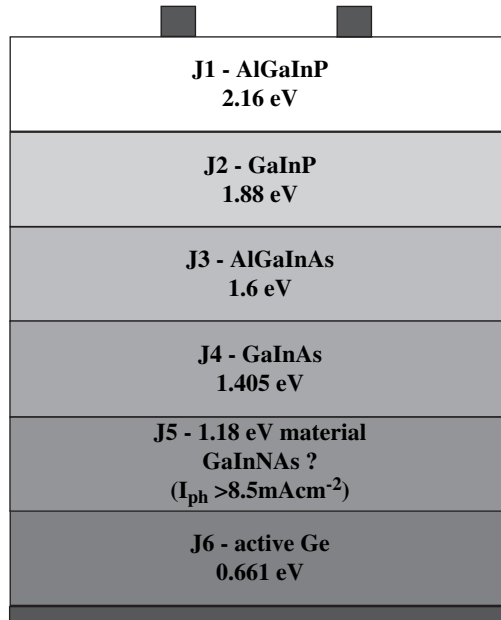

Fig. 13. Schematic cross-sectional view of a possible six-junction cell indicating the materials and bandgap values required. Junction 5 requires a 1.18 eV material, one possible candidate is GaInNAs.

the only Japanese commercial manufacturer of multijunction devices, together with Daido Steel Co. and Daido Metal Co. A near term aim of this project is the demonstration of a 40% device, under 500 suns concentration by April 2006. Work is also progressing on the use of AlInGaP (1.96 eV) [58] to replace the lower bandgap GaInP top cell material. There is also an investigation of the use of thin and alternative substrates (Ge and Si). Further into the future the so-called third generation concepts such as intermediate bandgap and hot-carrier devices [61] may become practical possibilities as advanced semiconductor materials are developed [62].

The greatest drive to develop devices with greater efficiencies remains the space industry where specific power is at a premium. Far term space missions have a demand for arrays with specific power values of ~ 1000 W/kg. To meet this concentrator systems will be required with MJ cell efficiencies above 48% [63]. The high material cost of substrates on which to grow the MJ devices remains a barrier to cost reduction. This is the rationale for the drive to grow the III–V materials on Si or other low cost substrates. During the development of the single junction III–V cells it was recognised that the high materials cost of single crystal wafers was a major drawback to their future exploitation. The high efficiencies achieved by MJ cells have reduced the effective cost per Watt; however, this could be further enhanced by using low cost substrates. In addition the mechanical strength and specific power (Watt per kg) could also be significantly improved. The lattice mismatch between Si and GaAs is approximately 4% and the thermal expansion mismatch is about 60% whilst the lattice mismatch between InP and Si is twice that for GaAs although the thermal expansion mismatch is less. The lattice-strain induced by these materials differences result in threading dislocations that can extend into the absorber layer and reduce the cell's performance. The growth of single junction III–V devices on foreign substrates was discussed earlier. However, the development of III–V MJ devices on substrates such as Si has continued and the use of SiGe alloys has provided

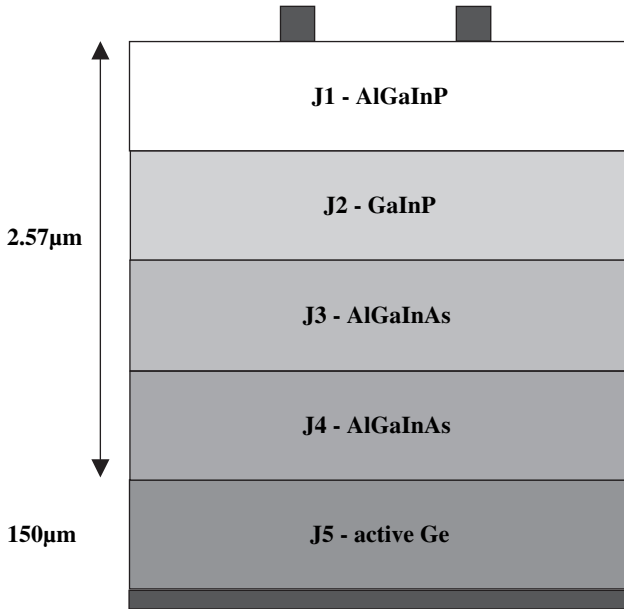

Fig. 14. Schematic cross-sectional view of the five-junction cell reported by Dimroth et al. [56].

a promising route to achieve this. McConnell and Matson [64] identified the use of Si substrates as part of the work on the next generation photovoltaic technology in the US. In particular there are projects at the California Institute of Technology investigating InP/Si bonded template films, and at Ohio State University considering III–V devices on Si substrates using SiGe buffer layers. The latter project has resulted in devices with promising performance [65,66].

Both to optimise cell design through the selection of sub cells with optimum bandgaps and to move towards higher efficiency devices it is necessary to use additional materials. As the number of junctions increases the design and production of the cell becomes more challenging. The thickness of each sub-cell needs to be controlled while also changing the composition to achieve the correct bandgap value, minimising lattice mismatch and creating the highly doped tunnel junctions between each sub-cell. The larger number of junctions increases the total thickness and radiation damage may be more severe for any junction at a depth corresponding to the end of range. The materials in this region and the junction's contribution to the cell may need special consideration that will depend on the intended radiation environment.

To achieve a larger number of junctions, an alternative materials system will be required that enables a wider variation in bandgap through the variation in composition while also minimising lattice mismatch. One of the materials systems that has recently received attention is the group III-Nitride alloys. The bandgap values of $\text{In}_{1-x}\text{Ga}_x\text{N}$ alloys range from 0.7 eV to 3.4 eV and the materials have been shown to exhibit superior resistance to radiation compared to conventional MJ solar cell materials [67]. The design of a high efficiency ($\sim 52\%$) four-junction device was found to depend on a 1.0 eV bandgap junction, immediately above the Ge. The material (GaIn)(NAs) can be lattice matched to Ge and a 1.0 eV cell based on this has been produced with an efficiency of 4.3% AM1.5 [68]. Mg has been used to dope GaN p-type and it may be possible to use SiC or ZnO substrates to grow the III-Nitrides

[69]. The Nitride materials electronic properties, growth rate and p type doping are seen as the main barrier to the exploitation of nitride materials at present [54].

3.3. Thermophotovoltaic devices

Nelson [70] gives a brief history of the development of thermophotovoltaics (TPV) up to 2002. An important source of information on all aspects of TPV are the proceedings of the Thermophotovoltaic Generation of Electricity Conferences which have taken place between 1994 and 2004 (TPV1–TPV6), and are published by the American Institute of Physics. Generally, TPV systems involve the conversion of radiation from man-made radiant sources into electricity using appropriate photovoltaic devices. The devices are required to convert longer wavelength radiation from lower temperature radiators 1000 K–2000 K, compared to the Sun (~ 6000 K). At present the maximum radiator temperature is limited to about 1500 °C (1770 K) because of the lack of suitable high temperature radiator materials and the need to avoid combustion products containing the oxides of nitrogen. This means that most of the radiation is in the infrared rather than the visible zone. The optimum bandgap of TPV devices lies in the range 0.4–0.6 eV for cells to be used with grey body radiators operating in the range 1200–1500 °C. Another major difference between solar PV and TPV is that in the latter the cells are in close proximity (a few centimetres) to the thermal source and in an ideal case the unconvertible radiation is returned to the radiator or never leaves the radiator. The devices operate at high energy densities similar to those in concentrator systems. Radiators can be grey body (broad band) radiators that have a near Plank's radiation law distribution or be selective such that there is a narrow spectral output corresponding to the region at and slightly above the bandgap energy of the cell. Generally some form of spectral control is required to optimise the coupling of convertible radiant energy into the cell and minimise the below bandgap energy lost from the radiator. Various theoretical estimates of the maximum performance of TPV systems and devices have been made [71–73]. These range from 85% for a solar TPV concentrator system with a two-junction cell [71], between 13 and 22% overall system efficiencies (including combustion efficiency) for a combustion based system [72] to between 35 and 40% for single and two bandgap cells converting blackbody like radiation [73].

The main III–V low bandgap materials include GaSb ($E_g = 0.72$ eV), InGaAs lattice matched (~ 0.75 eV) and mismatched (0.5–0.6 eV) to InP, InAsSbP (0.3–0.5 eV) [74,75], InGaAsSb [76,77] and 0.52 eV, InGaAs/InPAs cells [78]. The demands for such devices include the capability to operate at high current densities that are similar to those in concentrator devices (several Amperes per square centimetre). The low bandgap generally results in low V_{OC} . The monolithic interconnected module (MIM) structure is used to reduce current and increase voltage but at the cost of complexity and increased cost of processing. Currently most widely commercially available TPV devices are diffused pn junction GaSb cells produced by JX crystals in the US and used in their Midnight Sun TPV stoves [79]. Other III–V materials are all epitaxially grown by MOCVD and the device structures used for TPV include quantum well (QW) cells grown in InGaAs on InP wafers. These have been used to extend the absorption edge of the InGaAs from 1.7 μm to beyond 2.0 μm which would be near optimum to convert radiation from a 1500 K rare-earth, selective Holmia emitter with a peak emission at 1950 nm [80]. InGaAs based MIM [81,82] and InGaAsP/InGaAs tandem devices are grown on semi-insulating InP substrates with $\text{Si}_3\text{N}_4/\text{Au}$ back surface reflectors [83–86]. The semi-insulating InP is used to minimise free carrier absorption as the unconverted radiation passes through

the substrate and is reflected back towards the radiator and the back surface reflector is used to maximise the reflected radiation. GaAs/Ge devices have also been reported [87].

3.4. Quantum well cells and other device concepts

The growth processes used for III–V MJ cells give a high degree of materials control. The materials and processes are well placed to investigate device concepts that require nanometer scale changes in composition and properties. The quantum well (QW) solar cell is one of the more developed concepts. QW devices consist of an insulating layer (i-layer) within a conventional pn junction cell to extend the depletion region. Nanometer wide regions of lower bandgap material (QWs) are grown within the higher E_g barrier material. The QWs act to extend the absorption below the bulk material E_g . The additional carriers are released at room temperature if the field is maintained across the junction. The close control of material properties such as composition, abruptness of the QWs and doping, requires growth using MOCVD or MBE. The materials quality, processing technology and expertise available within the III–V community have resulted in QW devices being generally formed from III–V materials. A 50 well, strain balanced, QW solar cell was shown to have a higher efficiency than a p–n GaAs control cell. This device was grown by MOCVD [88].

Another approach that attempts to increase absorption within the depletion region of a cell is the metallic intermediate band solar cell (MIBCELL) or intermediate band solar cell (IBSC). Efforts to make these devices have included using MBE to produce InGaAs quantum dots within a GaAs pn junction [89].

The hot carrier concept relies on absorber layers that slow the thermalisation of photogenerated hot carriers within the lattice. A range of III–V materials has shown behaviour that indicates they may be used to investigate this phenomenon further, InGaAs multi-quantum wells, GaAs and InN have all shown slowed carrier cooling [61,90]. If the hot carriers can be extracted from the cell, then the efficiency of the cell can be increased because the energy normally lost to the lattice as phonons can be collected. One approach is to use a suitable material in which the phonons may not relax by the generation of acoustic modes. If this occurs the population of “hot” phonons increases and slows the carrier energy relaxation.

4. Solar cells based on the use of polycrystalline thin film compound semiconductors

4.1. Solar cells based on the use of CdTe

In 1956 Loferski showed that the optimum energy bandgap for photovoltaic solar energy conversion is 1.5 eV [5]. This led him to suggest that CdTe, which has a direct energy bandgap near to this value, and a high optical absorption coefficient for photons with energies greater than the energy bandgap ($\alpha > 10^5 \text{ cm}^{-1}$) is a promising PV material [46,47]. It was realised that thin layers, a few microns thick, were all that would be needed to absorb most of the incident light, minimising material costs. Also because a long minority carrier diffusion length would not be required (as most of the light would be absorbed in the depletion region) polycrystalline layers deposited using low cost processing methods might be adequate for producing efficient cells. The earliest cells to be developed were CdTe/Cu₂Te devices [91]. These devices were, however, found to be unstable. As the instability was identified with the use of Cu₂Te a novel device structure was developed that avoided its use, the CdS/CdTe heterojunction solar cell [92]. CdS has an energy bandgap of 2.42 eV, which is sufficiently wide to transmit most of

the solar spectrum to the device junction. It is also one of the few wide energy bandgap materials that can be strongly doped (n-type) minimising series resistance problems.

In 1972 Bonnet demonstrated the excellent potential of the CdS/CdTe cell by producing devices with efficiencies of 5–6% [93]. A schematic cross-sectional view of this type of device developed is shown in Fig. 15. For the device structure shown the layers were deposited in the sequence: CdS buffer layer, CdTe absorber layer and finally the back contact layer. Such a device is referred to as a “superstrate configuration device”. In this work both the CdS and CdTe were deposited using the “close spaced sublimation” method. This is a thermal evaporation method in which the source–substrate distance is very small (typically a few millimetres) and the layers deposited through an inert gas passed between the source and substrate. The high deposition temperatures used in this method results in CdTe layers free from secondary elemental phases method, and the production of dense, faceted grains. In common with other workers high efficiency devices only result if the deposited layer is treated with CdCl₂ or Cl₂ and the device annealed in air at 400 °C for 30 min. The CdTe is then etched in a solution of bromine in methanol, dipped into a solution containing orthophosphoric acid to introduce *P* into the back of the device and then the back contact deposited. Further research by Bonnet and co-workers and complementary work (mainly in the USA) led to the development of CdS/CdTe devices with efficiencies > 10% and eventually to Bonnet setting up ANTEC GmbH (in Germany) to manufacture commercial modules [94,95]. The other major manufacturer of CdTe based devices is First Solar in the USA; they also use a thermal sublimation process to deposit the CdTe layers [96].

In parallel with the development of CSS based devices other methods have been used to produce CdS/CdTe solar cells. These include spray pyrolysis (Golden Photon [97]) electrodeposition (BP Solar [98]) and screen printing (Matsushita [99]). These companies have, however, now ceased production. This is for a range of different reasons. These include lack of cell stability for cells manufactured using spray pyrolysis and the difficulty in scaling up the wet chemical processes to achieve targeted production yields for the latter two processes. It is possible that Matsushita may shift to using CSS in the near future [97]. Alternative methods with potential for producing low cost devices include sputtering [100] and stacked elemental layer (SEL) processing [101]. A possible advantage of using these methods is that it is possible to deposit and form CdTe from the constituent elements; this may result in lower densities of residual impurities than achieved with using the compound due to the ease of controllably purifying the low melting point elements compared to the high temperature compound.

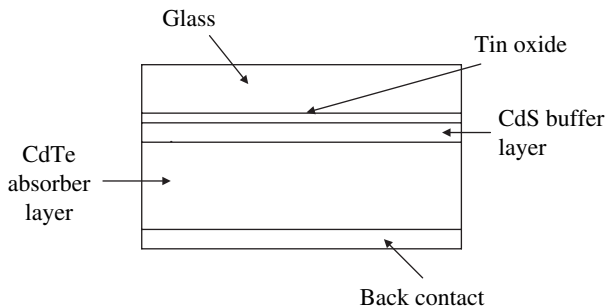

Fig. 15. Schematic cross-sectional view of a “superstrate configuration”, CdS/CdTe device structure.

The highest efficiency CdTe-based solar cell produced to date is that made by Wu and co-workers at NREL [102]. This device was produced by depositing layers in the sequence Cd_2SnO_4 , Zn_2SnO_4 , CdS, CdTe and finally the back contact. The improvement is due to the Cd_2SnO_4 layer being both more transmissive and more conductive than $\text{SnO}_2\text{:F}$, increasing the amount of light reaching the interface and lowering lateral resistance losses. The inclusion of a Zn_2SnO_4 layer between the Cd_2SnO_4 layer and the CdS buffer layer was introduced to improve V_{OC} and FF.

This type of structure has advantages when the technology is scaled up in that the Cd_2SnO_4 , Zn_2SnO_4 and CdS can be rf sputtered in argon at room temperature from hot pressed targets, speeding up throughput by eliminating warm up and cool down times for the substrates and sources. The CdTe is deposited using CSS at 570–625 °C and the samples were then heat treated in CdCl_2 vapour at 40–420 °C for 15 min. It is mainly during the CdTe deposition that the Cd_2SnO_4 , Zn_2SnO_4 and CdS layers are recrystallised and interdiffusion promoted at the interfaces of the materials. It is expected that the commercial CdTe cell manufacturers i.e. ANTEC and First Solar will incorporate the stannate layers into their production processes over the next few years.

Considerable effort has been made over the years to understand the role of the CdCl_2 heat treatment and back surface etching [8]. The CdCl_2 treatment is known to recrystallise and densify the grains, promote interdiffusion of the CdS and CdTe at the interface to relax stress at the interface, to passivate the grain boundaries to a substantial extent and to remove interstitial Te and Cd vacancies. In an XPS study the energy band profile of CdS/CdTe devices has been determined [103]. Cl appears to dope the CdS more strongly n-type and to dope the CdTe n-type at the CdS/CdTe interface while the back surface etching, the air anneal and the choice of back contact material tends to dope the CdTe/back metal contact interface p-type. The role of Cl as a donor is also supported by photocapacitance measurements [104]. This means that the highly efficient devices are probably a type of buried homojunction device.

4.2. Solar cells based on the use of the chalcopyrite compounds

The chalcopyrites are compounds based on the use of elements from groups I, III and VI of the periodic table and include copper indium diselenide (CuInSe_2) copper gallium indium diselenide ($\text{CuGa}_{1-x}\text{In}_x\text{Se}_2$) and copper indium disulphide (CuInS_2). As with amorphous silicon and cadmium telluride these materials have direct energy bandgaps and high optical absorption coefficients for photons with energies greater than the energy bandgap making it possible for a few microns of absorber layer material to absorb most of the incident light and reducing the need for a long minority carrier diffusion length.

In 1974 Wagner et al. produced a $\text{CuInSe}_2/\text{CdS}$ solar cell with an efficiency of 12%, an outstanding achievement at the time [105]. The device was produced by depositing a thin film of CdS onto a wafer of single crystal CuInSe_2 . The promising result stimulated research into developing cells in which all the layers were deposited using thin film methods [106]. It was also realised that incorporating Ga into the CuInSe_2 to produce $\text{CuGa}_{1-x}\text{In}_x\text{Se}_2$ (CIGS) resulted in a widening of the energy bandgap towards to the optimum for photovoltaic solar energy conversion, an improvement in crystallinity of the layers, and opened up the possibility for grading the energy bandgap. CIGS has in fact proved to be the most successful chalcopyrite absorber layer investigated to date [107,108]. It should be noted that adding too much gallium results in the layers being too highly resistive for use in solar cell structures. An energy bandgap of 1.25 eV corresponds to the maximum widening achievable without loss of efficiency and hence most CIGS devices are produced with such an energy bandgap. The other chalcopyrite

semiconductor of interest is copper indium disulphide. This material has a direct energy bandgap of 1.5 eV, near the optimum for solar energy conversion and it therefore has the potential to be a strong candidate for producing efficient devices. Most of the work on this material has been pioneered by the Hahn–Meitner Institute in Berlin who usually produce this material by co-evaporating the elements onto heated Mo-coated glass substrates [109].

Although a wide range of methods has been used to produce chalcopyrite thin films three methods have dominated both research and large scale production.

These are:

1. co-evaporation of elements,
2. selenisation/sulphidisation of elemental precursor layers, and
3. stacked elemental layer (SEL) processing.

The former method was used by Mickelson and Chen, in 1981 to produce the first 10% all thin film cell based on the use of CuInSe_2 [110]. It has also recently been used by NREL to produce the highest efficiency thin film CIGS devices produced to date (efficiencies > 19%) [107]. It is also the method commercialised by ZSW, Stuttgart and Würth Solar in Germany who produce modules with efficiencies up to 13 % [111].

The second method was initiated by Basol and Kapur in 1989 [112]. The third method was developed at Newcastle Polytechnic, now Northumbria University by Knowles and co-workers [113]. Up-to-date reviews of the development of thin film devices have been given by Ullal (and co-workers) at IEEE Photovoltaic Specialist Conferences and European PV Solar Energy Conferences [114,115].

Siemens Solar produce $\text{CuGa}_{1-x}\text{In}_x(\text{S}_{1-y}\text{Se}_y)_2$ (CIGSSE) rather than CIGS absorber layers for use in their commercial modules. In their case they start by depositing a Cu/Ga/In/Se precursor layer which they convert into CIGSSE by rapid thermal annealing in a sulphur containing environment. They have achieved efficiencies up to 14.7 % for 10 cm × 10 cm mini-modules [116].

It should be noted that most of chalcopyrite-based devices are usually deposited in the substrate configuration i.e. in the order: back contact, absorber layer, buffer layer, TCO and then a top contact grid. The back contact usually used is molybdenum, the buffer layer CdS and the TCO, Al-doped ZnO. A typical substrate configuration structure is given in Fig. 16.

The passivation of grain boundaries and other surfaces in chalcopyrite semiconductors is attributed to the presence of sodium ions and oxygen (from an air anneal) [109]. The sodium may diffuse into the absorber layer from the soda lime glass substrates used, although it is now more common to introduce them directly into the layer by adding an inorganic source of the ions to the material to be evaporated or sputtered.

There has been much recent research interest into: (i) developing a Cd-free buffer layer to replace the CdS layer currently used, (ii) replacing the Ga and In with elements that are more abundant. Strong candidates to replace the CdS are ZnSe, ZnIn_2Se_4 and MgZnO [117,118]. Replacing the Ga in CIGS with Al is proving to be very promising [119]. Some workers have gone further and replaced the Ga and In with Zn and Sn to produce $\text{Cu}_2\text{ZnSnS}_2$ solar cells [120].

At Northumbria we can produce high quality Cu/In precursor layers using rf sputtering and we have experience of converting these into good quality CuInSe_2 [121,122] and CuInS_2 , the latter by a range of novel processes developed at Northumbria: high pressure sulphidisation, low pressure sulphidisation using argon as a carrier gas to carry S vapour to the precursor layers and using anodic sulphidisation [123]. We have also developed $\text{ZnS}_{1-x}\text{Se}_x$ layers for use as

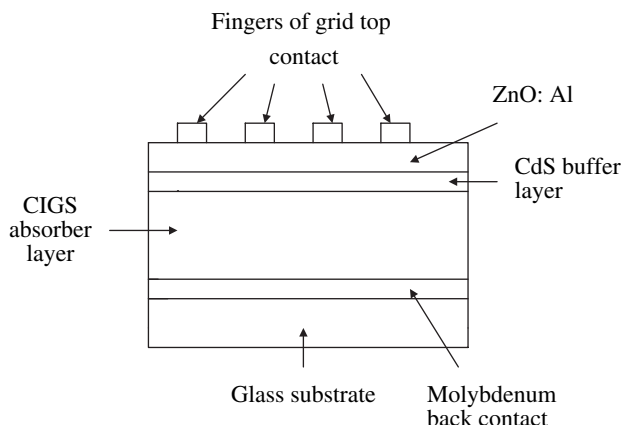

Fig. 16. Schematic cross-sectional view of a “substrate configuration” chalcopyrite device structure.

buffer layers to CuInS_2 , as this system creates the possibility of lattice matching across the junction [124,125].

5. Dye sensitised and organic solar cells

5.1. Dye sensitised solar cells

An alternative to the all solid state solar cell is the use of a photo-electrochemical cell. To date the most successful cells of this type are the dye sensitised cells developed by Gratzel and co-workers, which are now commonly referred to as “Gratzel cells” [126,127]. With this device (Fig. 17) the top electrode is made by screen printing a layer of TiO_2 onto fluorine doped SnO_2 coated glass and a dye applied to the TiO_2 . The surface of the TiO_2 is very rough to increase the surface area and to improve light absorption. The dye usually consists of a transition metal complex based on ruthenium or osmonium. The bottom counter electrode is made by screen printing a thin layer of pyrolithic platinum onto fluorine doped SnO_2 coated glass. The device is completed by adding a suitable electrolyte (usually an iodine based solution) between the electrodes and sealing the edges to prevent escape of the electrolyte. A detailed study of long term stability of these devices has been made and the efficiency confirmed to be 8.2%

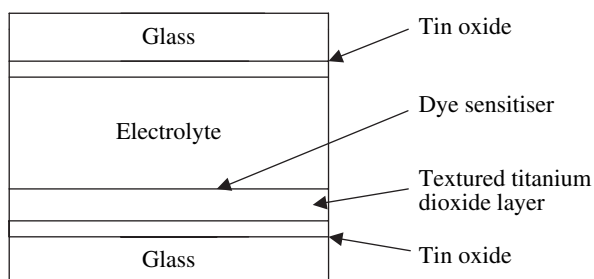

Fig. 17. Schematic cross-sectional view of a Gratzel electrochemical cell using an iodine ion based electrolyte and dye sensitised TiO_2 electrode to absorb the light.

efficient for a cell area of 2.36 cm² and 4.7% for a submodule of area 141.4 cm². An efficiency of 11% has also been reported for a 0.25 cm² area device [128,129]. Although such cells are in principle cheap to produce it is not yet clear where and how well they will compete with conventional cell technologies.

5.2. Organic solar cells

The organic materials that are of most interest are molecular and polymeric semiconductors and fullerene (C60) and its derivatives [130–137]. The former materials are well known for their use in organic LEDs (now developed by companies such as Pioneer in Japan) and for making thin film transistors for use in smart cards (as being developed by Philips, Holland) [130]. The potential advantages of using these materials include simplicity of deposition processes that can be used, e.g. many of the materials are solution processible such that spin coating of substrates is possible, and that all-polymer-devices should be flexible and hence easy to use for a wide range of applications. The cell structure used for most of these devices starts with an indium tin oxide coated glass substrate which also acts as the transparent top electrode to the device. A layer (or layers) of light absorbing organic material (or materials) is deposited onto indium tin oxide. The device is completed by depositing a back contact (usually a metal) onto the organic material(s). Initial studies just used one absorbing material between the two co-planar electrodes; however, carrier collection is poor resulting in low device efficiencies. The strategies most commonly adopted to overcome this problem are to deposit two organic layers such that they are in intimate contact e.g. PPV and C60, phthalocyanine/perylene derivatives or CN-PPV/MEH-PPV. The idea is that one of the materials is an electron acceptor and the other a hole acceptor; these materials are in such intimate contact that when the carriers are generated they are extracted without the need to diffuse too far (≈ 10 nm). Reported values for cell efficiencies are currently $< 5\%$ and data on the important issues of cell stability, energy payback times and ratios are not available as yet. This means that in the short term, successful commercial developments of this type of technology are probably for in-door products rather than for large scale power generation applications. Whether or not these types of devices can be developed as the large scale power generation market is the major challenge for research in this area in the future.

Note:

PPV is poly(*p*-phenylenevinylene),

MEH-PPV is poly(2-methoxy-5(2-ethyl-hexyloxy)-*p*-phenylenevinylene),

CN-PPV is cyano poly(*p*-phenylenevinylene).

6. Energy analysis

6.1. Introduction to energy analysis

Energy analysis is a technique used to determine the energy flows in industrial processes and it has been widely utilised in the assessment of energy production technologies. Since the mid-1970s, it has been used to assess various PV cell technologies and production methods and remains an important assessment methodology today, allowing the calculation of the required energy input for unit output of product. Energy analysis was developed in the 1960s

and became more widely used after the Oil Crisis of the 1970s. This had alerted people to the potential of renewable energies. In order that energy analyses may be performed consistently for different energy production technologies, a set of conventions was set up by the International Federation of Institutes of Advanced Study (IFIAS), launched in 1972 which standardised the parameters and definitions used [138]. The IFIAS convention embodies the concept of levels of energy analysis, and usually three or four levels are used in the investigation for PV technologies. These are as follows:

- Level 1 – direct or process energy requirement,
- Level 2 – final materials manufacture,
- Level 3 – raw materials and capital,
- Level 4 – manufacturing equipment to produce materials in Level 3.

Higher levels do exist but require a large volume of information, whilst only adding minor corrections to the totals of the other levels and thus are not usually included.

The production technology to be studied is usually broken down into individual process steps, the energy requirement of each process step is calculated and these are summed to give the energy requirement of the candidate technology. The energy requirement of each process step comprises three quantities, which are summed together. These are materials, machine and process energy requirement. The materials energy requirement is the amount of energy consumed in manufacturing the materials that appear in the finished product. The amount of material required is calculated from the film thickness allowing for material yield within the deposition process and for the process yield. This is defined as the proportion of product from that step which is of acceptable quality to go forward to the next processing step. The machine energy is the amount of energy consumed in the manufacture of the production equipment used for the processing step. It is not generally possible to determine the energy input of production machinery explicitly and it is an accepted practice to relate the energy content directly to the capital cost of the equipment. Process energy is the amount of energy used to perform the process step. The majority of this is in the form of electrical energy; however, this may also include materials used in processing such as gases that do not appear in the finished product.

The energy payback time and energy ratio of a production technology can be calculated from the energy requirement. The energy payback time is the time taken for the particular type of module to pay back the energy required in its manufacture. This is dependent on the solar insolation level, which is dependent on the location at which the module is operating. The energy ratio is the ratio of the total amount of energy produced during the lifetime of the module to the amount of energy taken in its production. This again is location dependent and would vary with the expected lifetime of the module. Most studies have assumed a lifetime of 25 years, and this is consistent with expectations of the PV companies. Many studies look at a range of lifetimes, ranging from 10 to 30 years.

6.2. Energy analysis of PV cells/modules

Initial energy analysis studies were published in the mid-1970s with the majority considering IFIAS Level 4. Studies were published on various PV production technologies, and the results mainly given for 25 cm² cells. Typical results were published as kWh/kg of silicon and MJ/cell.

Several studies were published on monocrystalline silicon cells, this being the most popular technology at that time, and efforts were being made to reduce the energy requirement of the processing, particularly in the production of the multicrystalline silicon. Hunt [139] investigated the energy use in the production of silicon solar cells from raw materials to finished product, detailing the energy requirement at the different processing stages of the silicon material. He estimated the energy requirement for single crystal silicon cells to be 112.3 MJ/cell giving an energy payback time of about 12 years for terrestrial cells and up to 24 years for those cells used in space applications. Hunt's work was readily accepted by the PV industry, due to the fact that he worked for the Dow Corning Corporation, a major processor of silicon material, and therefore his process data was reliable. Other early studies on silicon were published by Lindmeyer [140], Fischer [141] and Wolf [142], giving total energy requirements in kWh/kg of silicon as 801.4, 2290 and 2560, respectively. However, Lindmeyer's work only considers Level 1 inputs. Iles [143] looked at the energy requirements from Czochralski growth to the testing of the cell. These studies were compared by Hay et al. [144] and broken down to show the materials, machine and process energy. Fischer [141] also looked at the energy requirements for the production of polycrystalline silicon cells by the three main methods used at the time and concluded that casting the ingot and then producing a multicrystalline foil were the least energy intensive processes, giving a cell energy requirement of 3.9 MJ.

Initial work on the energy requirement for amorphous silicon was published by Riddoch and Wilson [145] as a continuation of the cell development work at Heriot Watt University in Scotland. It was calculated as 3.6 MJ/cell for an MIS cell with the amorphous silicon deposited by the RF glow discharge of silane. Early energy analysis studies of thin film cells mainly concentrated on the CdS/Cu₂S cells. Jenkins and Harrison [146] looked at sputtered CdS cells with an energy requirement of 1.1 MJ/cell and Bloss et al. [147] looked at a technology based on thermal evaporation of the CdS layer, giving an energy requirement/cell of 1.4 MJ/cell. Further studies on thin film cells were undertaken by Hynes et al. [148] on CIS based cells using different production technologies based on thermal co-evaporation and electrodeposition. These gave an energy requirement of 400 kWh (thermal)/m² for the thermally evaporated cell and 250 kWh (thermal)/m² for the electrodeposited cell. This work also investigated the effective CO₂ emissions for the technologies and looked at the sensitivity of the total energy requirement to the various process parameters. Hynes et al. [149] also analysed the energy requirement of two types of thin film CdTe modules based on vacuum and non-vacuum processing. This work gives the energy requirement for the non-vacuum technology of 275.7 kWh (thermal)/m² and 329.9 kWh (thermal)/m² for the vacuum processing. This results in energy payback times of 0.6 years for a 10% module operating in southern Europe and an energy ratio of 24 for the non-vacuum processed cell. For the vacuum processing this rises to an energy payback time of 0.8 years with the energy ratio reduced to 20.

Hagedorn's work [150] on the hidden energy in solar cells and power stations in 1989 was the first on silicon cells and modules for about 10 years and his work has been used as the basis for energy studies of silicon ever since. He calculates the energy payback times for monocrystalline, multicrystalline and amorphous silicon for two scenarios as between 1.7 and 6 years for cells/modules and 7.3 and 2.6 years for power stations. This work was then extended by Palz and Zibetta [151] to ascertain whether the energy payback time was a bottleneck for the further implementation of PV. They concluded that energy payback times of this length are not prohibitive and further industrialisation of the processing technologies involved would reduce current values. Also the current energy payback times were comparable to those of large scale electricity production in fossil and nuclear power plants.

Energy analysis studies have been undertaken at the University of Utrecht since the early 1990s and Alsema has published studies on several technologies including crystalline and amorphous silicon and CdTe thin film cells. A comprehensive review of the terms involved and the energy requirement and payback times of thin film modules can be found in Ref. [152]. He was commissioned by the Netherlands Agency for Energy and the Environment (NOVEM) to report on the Environmental Aspects of Solar Cell Modules in 1996 [153] and this included a detailed study of the energy analysis of multicrystalline silicon, amorphous silicon, cadmium telluride and copper indium diselenide including energy requirements and energy payback time. Alsema also compares his results with and discusses the studies of Hagedorn and Palz and Zibetta, mentioned earlier. For multicrystalline silicon, Alsema estimates 399 kWh (thermal)/m² with an energy payback time of about 1.3 years. For amorphous silicon modules he estimates 224 kWh (thermal)/m² and an energy payback time of 1.2 years. For the thin film materials, the energy requirement is 304 kWh (thermal)/m² and an energy payback time of 1.1 years.

In Ref. [154], Alsema et al. include values for single crystal silicon of between 47 and 109 MJ/Wp depending on the method of silicon feedstock production. This paper also discusses the energy requirements of balance of system components and gives energy payback times for different types of modules used in different applications for present day and expected future technologies. More recent studies by Alsema and de Wild-Scholten have investigated multicrystalline silicon technologies and energy payback times of 1.2 years [155]. The most recent results have been obtained in collaboration with several PV companies so that really accurate, state-of-the-art data can be analysed for ribbon, multi- and single-crystal silicon. Energy payback times of 1.5–2.5 years were found for southern European locations [156]. Reductions in the energy requirement of up to 25% are expected due to improvements in the technology, which will reduce the energy payback times further.

Knapp and Jester [157] have investigated the energy payback time of single crystal silicon and copper indium diselenide thin film cells. Energy payback times of just under 2 years were quoted for the copper indium diselenide cells and just over 3 years for the single crystal silicon cells with energy ratios of between 9 and 17. This paper also discusses and compares the results of several studies mentioned previously in this review.

The novel technology of sliver cells has also been investigated with regard to embodied energy [158]. The authors quote a reduction in the consumption of silicon by a factor of 5–12 compared to conventional crystalline silicon modules, thus decreasing the number of wafers needing to be processed to produce a kW rated system by a factor of 15–30. A detailed breakdown of the comparison with conventional silicon processing is given. Energy payback times for the sliver cells of 1.5 years have been estimated which are similar to those for crystalline silicon [155,156].

6.3. Energy analysis of PV systems

Peharz and Dimroth [159] have investigated the embodied energy in a high concentration PV system. Energy payback time has been calculated as 8–10 months for a system built in Germany and operated in Spain, and 12–16 months for the system installed in Germany. They calculated that the energy intensive material was the zinc-coated steel used in the tracking unit. This paper gives a detailed list of the individual components and their CED (cumulative energy demand). Raugei et al. [160] have undertaken a study of cadmium telluride modules, obtaining

production data from the company ANTEC Solar GmbH. An energy payback time of 0.9 years has been estimated for the 2004 technology.

Energy analysis studies have also been undertaken for installed systems. Hynes et al. [161] published an energy analysis of Northumberland Building in the UK, the first building integrated PV system in the UK. This system is on the façade of an office block and is 39.5 kWp. The total energy requirement of the system was 561,102 kWh (thermal), giving an energy payback time of just over 4 years and energy ratio of about 7. Although the energy ratio is a little low, this study shows that for a northern location and 1994 technology it is possible for a demonstration system to have a relatively low energy payback time. Such studies are valuable since the energy intensive parts of the system can be identified and improved upon. Kato et al. [162] investigated a 3 kWp residential system and considered crystalline, polycrystalline and amorphous silicon modules. Energy payback times of between 3.3 and 11 years were obtained for the crystalline silicon, 1.5 and 2.4 years for the polycrystalline silicon and 1.1 and 2.1 for the amorphous silicon cells.

7. Environmental issues

7.1. Introduction and historical background

As PV technology was developed, it was not until the 1980s that researchers began to consider the environmental implications of this technology and pressure was being applied by parts of the scientific community and administrators that all costs of energy systems, renewable and traditional, should be taken into account. The oil crisis had demonstrated the need to reduce the world's dependence on imported oil whilst the Chernobyl accident had alerted the world to the hazards of nuclear power. Other environmental problems such as global warming and acid rain also reiterated the need to decrease dependence on fossil fuels.

A German–American workshop was organised in Ladenburg, Germany in October 1990 to discuss the “External Environmental Costs of Electric Power: Analysis and Internalization” [163]. Papers at this workshop considered environmental damage and ways in which environmental costs may be internalised. PV was not discussed specifically at this workshop; however, the impacts of external costs on wind energy were covered and this could be relevant for the PV industry. Ottinger's group at Pace University, Centre for Environmental and Legal Studies published an extensive review of environmental costs/risks and covered all electricity generation technologies, including photovoltaic installations [164]. Various environmental costing models were also discussed and this has formed the basis of many of the studies on external/environmental costs that have been published. Sorensen [165] published an extensive report on life cycle analysis with regard to energy systems. This report outlines the principles of life cycle assessment and how it may be applied to energy systems, particularly renewable energy technologies. The methodology developed was applied to multicrystalline and amorphous silicon cells [166] and gives a comprehensive breakdown of the technologies involved and how the life cycle analysis is structured. The results are divided into environmental, social, economic and other impacts.

7.2. External costs

The ExternE project was introduced and funded by the European Commission in order to develop a methodology to calculate the external costs caused by energy consumption and production. External costs are defined as the monetary quantification of the socio-environmental

damage, expressed in eurocents/kWh, with the possibility of providing a scientific basis for policy decisions and legislative proposals such as subsidising cleaner technologies and energy taxes to internalise the external costs. The ExternE project looks at all energy production technologies using one methodology developed for this project which allows the various fuel cycles to be compared. An outline of the initial results for the PV fuel cycle is given in Refs. [167,168]; however, the initial study was for a very small sample of PV systems and the results are not consistent. There has been pressure from the PV industry for the PV fuel cycle to be re-done using a larger sample of more representative systems. Full documentation on the ExternE project can be found at http://europa.eu.int/comm/research/energy/pdf/externe_en.pdf. One of the earliest publications from this project was by Baumann et al. [169]. In this paper the author outlines the basic assumptions and requirements of the methodological framework for the quantification of external costs and compares the environmental effects of different energy technologies, including renewables and the conventional technologies, coal, oil, nuclear and natural gas.

7.3. Life cycle analysis

As discussed earlier, life cycle analysis has been used as an analytical tool for PV cells. A product's life cycle starts when raw materials are extracted from the earth, followed by manufacture, transport and use and ends with waste management including recycling and final disposal. It is often called a "cradle to grave" approach. At the present time, there are efforts to find a common methodology to use that will provide a consensus amongst the groups working in this area. The EC via its Joint Research Centre in Ispra, organised a Workshop in March 2004 [170] in order to gather together all experts in the field in two areas, Life Cycle Analysis and Recycling issues and the proceedings of this workshop give a full review of the issues and methods used within this area. The recycling issues will be discussed later in this section. There have been several hundreds of publications in the area of Life Cycle Analysis and Assessment and it would not be feasible to include every publication in this review. However, there are a few key players in this area and their work will be included. Alsema and van Engelenberg [171] studied CdTe and CIS thin film modules by means of a life cycle assessment of Cd, Te, Se and In material flows. They also present energy analysis of these module types and investigate Cd and Se emissions. These emissions were found to be of the same order of magnitude as those from a modern coal plant. Major environmental bottlenecks may arise from the air emissions during roof fires and from uncontrolled module waste. Module design which reduces fire emissions and efficient waste collection and recycling schemes should be considered to alleviate these bottlenecks. van Engelenberg and Alsema also studied the environmental risks of amorphous silicon modules [172]. Again the life cycle assessment was done using material and energy flows. They find no serious risks expected from amorphous silicon module production, and use. However, significant environmental releases such as tin oxide, chloride and fluoride are not specific to amorphous silicon modules and attention must be given to the safety risks related to silane storage and handling. Hynes et al. [173] investigated the environmental impacts of thin film cadmium telluride modules using life cycle assessment. With large scale production it is likely that only Te would pose supply problems due to limited reserves. Possible environmental and health impacts could occur at the production and disposal stages although these should be reduced using normal safe working practices. An environmental life cycle assessment of multicrystalline silicon solar cells was published by Phylipsen and Alsema [174]. This is an investigation by means of environmental life cycle analysis on multicrystalline

silicon cells concentrating mainly on energy and material flows. The main conclusions of this study are as follows. The possibility of recycling silicon wafers both from production waste and at end of life should be investigated. Methods should be investigated to reduce the emission of fluorides in water, and the emissions of volatile solvents and alcohols should be avoided. The use of silver for contacts should be reduced to avoid problems with resource availability. Alsema is currently working on the Crystal Clear Integrated Project funded by the EC and he is performing life cycle analysis on crystalline silicon technologies, using detailed production data supplied directly from the PV companies involved in the project. This will extend his recent study of advanced silicon solar cell technologies [155]. These new technologies are expected to reduce greenhouse gas emissions of PV systems in southern Europe to about 30 g/kWh. Frankl et al. have also published extensively in the field of life cycle assessment and has been involved in the EC funded ECLIPSE project (Environmental and eCological Life cycle Inventories for present and future Power Systems in Europe) [175]. The goal of this project was to introduce harmonisation and transparency into life cycle analysis and to provide a database for recent and emerging PV technologies. This has included four main technologies, single crystal, multicrystalline and amorphous silicon and copper indium diselenide and several applications in buildings under different insolation conditions. More than 170 unit processes have been described. These and further detailed information can be found at <http://www.eclipse-eu.org>. Fthenakis et al. [176] also argue the case for an agreed system for life cycle analysis based on an agreed framework. They outline the currently available information databases, including ECLIPSE, and current studies which may develop the tools required.

An Expert workshop was held in Utrecht in June 1997, and addressed issues such as environmental aspects of PV power systems, energy payback times, CO₂ mitigation potential, life cycle assessment, and health and safety assessment and control. Selected papers from this workshop can be found in Ref. [177], and include prevention and control of accidental releases of hazardous materials, health, safety and environmental risks from the operation of CdTe and CIS thin film modules, life-cycle air emissions from PV power systems and life cycle analysis of PV systems in buildings.

7.4. Environmental assessment

Scientists at Brookhaven National Laboratory in the USA, have been publishing health and environmental information of interest to the PV industry since the 1970s mostly funded by the United States Department of Energy. The work was started by Moskowitz and then continued until the present day by Fthenakis. It was the early studies by Moskowitz that first alerted the PV industry and environmental scientists to the possible hazards associated with the manufacture, use and disposal of PV modules. Information on all types of PV cells and modules has been published. In 1995, they published a comprehensive study of the health and environmental issues of the manufacture, use and disposal of thin film cells [178]. They examined the hazards associated with producing and using Si, CdTe and CIS thin film modules. Focussing on the potential of workers in manufacturing facilities to be exposed to chronic, low levels of Cd. They also review regulations and control options that may minimise the risks to workers. They also discuss recycling and disposal options for spent modules. The conclusions of this study are that large scale manufacture of Si, CdTe and CIS thin film PV cells may present health and safety hazards if adequate precautions are not taken. The most significant safety hazards are related to the use of pyrophoric SiH₄ in the manufacture of amorphous silicon cells. Health effects are related mainly to Cd compounds, and as there is relatively little

information available on the inhalation of such compounds then exposure to them must be strictly controlled.

Hynes, Baumann and co-workers in the UK have published several papers on environmental aspects of many thin film deposition processes. These include environmental risk assessment and hazard assessment of the manufacture of CIGS based thin film PV cells [179], the chemical bath deposition of CdS [180] and the deposition of alternative window materials to CdS for use in thin film modules [181]. Steinberger from the Fraunhofer Institute in Munich has investigated such risks of CdTe and CIS thin film modules in the operation phase [182], considering hazards that may occur due to fire, weather influences or damage of the module due to mishandling. Steinberger firstly identifies the amount of material in the modules and then investigates the concentrations of selenium, cadmium and tellurium in the air due to a fire lasting about 1 h. His results show that there is no acute danger posed by such fires, and that releases of cadmium or selenium from a burning PV module are less than those given out by a coal fired power station in normal operation. Fthenakis [183] has considered the cadmium emissions from cadmium telluride thin film cells. He has taken a cradle to grave approach and comes to some interesting conclusions. The Cd present in a Ni–Cd battery is elemental Cd and not CdTe, a much more stable and insoluble form. Coal and oil burning power plants routinely produce Cd emissions, whilst a PV cell does not produce any Cd emissions during its operation. Cd is produced as a by-product of zinc production. It can either be used or discharged into the environment, where it is normally cemented and buried or landfilled as hazardous waste. Encapsulating it as CdTe in a PV module is a much more environmentally friendly method of disposal.

The MUSIC-FM project, funded by the EC, was undertaken in the 1970s to look at the up-scaling of PV towards 500 MWp/year. Part of this project was to investigate the health, safety and environmental issues of thin film PV manufacturing. Factors such as energy requirement, resource depletion, use and emissions of toxic materials and waste management were considered for CdTe, CIS and amorphous silicon technologies [184]. The conclusions of this study were that for these thin film materials, there were no serious environmental bottlenecks for upscaling to the higher production levels. Adequate methods were available for the treatment of manufacturing waste. However, in the longer term issues regarding CdTe and CIS module waste treatment and In and Te resource availability and module recycling should be addressed.

Meijer et al. [185] have undertaken a life cycle assessment of higher efficiency modules, stating that a higher efficiency does not necessarily mean a lower environmental impact. They analysed the production and use phases of an indium gallium phosphide on multicrystalline silicon tandem module, a thin film indium gallium phosphide cell module and a multicrystalline silicon module. The evaluation of the indium gallium phosphide was for a limited production scale and a fourfold reuse of the GaAs substrates is assumed. The environmental impacts of the tandem module and the thin film indium gallium phosphide module are estimated to be, respectively, 50 and 80% higher than those for the multicrystalline silicon module. The energy payback times for the tandem module, the thin film indium gallium phosphide module and the multicrystalline silicon module are estimated to be 5.3, 6.3 and 3.5 years, respectively. Improvements in the environmental performance could be gained from improved materials efficiency in production and reuse of the gallium arsenide wafer, as well as a higher energy efficiency of the metalorganic chemical vapour deposition process. The higher energy payback time for the multicrystalline module is higher than for other studies based on similar assumptions. This is due to the small production volume assumed.

7.5. Recycling

Most PV companies now are actively moving towards recycling of their products, both for manufacturing waste and end of life modules. The leaders in this area are Deutsche Solar in Germany and First Solar in the USA. Deutsche Solar have developed a dedicated recycling solution as a service to the PV industry. They have proposed a voluntary take back system capable of growing to meet future waste recycling demands. The line will be capable of processing crystalline silicon and thin film modules. Comprehensive details are given in Ref. [186]. The silicon recycling is now at pilot stage and reuse of silicon material will be timely for the industry [187].

Soltech in Belgium have developed a recycling process for silicon cells [188]. The reclaimed silicon wafers preserved their quality, providing high efficiency recycled silicon cells. They performed a life cycle analysis on the reclaimed wafer and that recycled wafer only consumed 2.17 kWh/wafer compared to 9.32 for the virgin material. This reduced the energy payback time from 4.92 to 1.14 years, based on solar insolation in continental regions.

First Solar (formerly Solar Cells Inc.) manufactured CdTe thin film PV. They have been developing their recycling processes for nearly 10 years and were one of the first PV companies to set up a recycling facility. They have developed two recycling technologies for CdTe modules at end of life modules and as manufacturing scrap prior to lamination. A process for recycling crystalline silicon material has also been developed. Full details of their processes can be found in Ref. [189].

Drinkard Metalox from the USA, has developed a recycling process for recycling thin film modules such as CdTe and CIS, which deals with end of life modules and manufacturing scrap. Details of this process are given in Ref. [190]. Eberspacher from UNISUN reported on strategies for recycling CdTe PV modules [191] in collaboration with Brookhaven National Laboratory. They looked at methods adopted by related industries such as the battery industry, and include some cost information. InterPhases research in the USA developed a novel electrochemical approach to recycling CIS and related modules [192]. This process is capable of recycling end of life and damaged modules and consists of a one loop closed system. The films are dissolved from the substrates and then the semiconductors are separated and retrieved. Research has also been undertaken into recycling of materials from specific parts of the production process itself, rather than just the modules. Malinowska et al. [193] have recycled and reused chemicals from the deposition bath for deposition for chemical bath deposition of CdS. The baths were recycled up to three times and reagents replenished. The pH is adjusted with potassium hydroxide and the process is easily controllable and relatively simple to upscale for industrial use. Dhere et al. [194] have also investigated CdS bath recycling and toxic waste reduction utilised in the production of CIS based cells. They were able to reuse the CBD solution without affecting the CdS film properties and the amounts of materials added to the bath were optimised to achieve required CdS thickness. Fthenakis [195] presented a feasibility study for recycling thin film cells and manufacturing waste, based on the current collection/recycling infrastructure and on current and emerging recycling technologies. Centralised and decentralised recycling strategies are also discussed.

8. Conclusions

Most solar cells manufactured and sold are based on the use of multicrystalline silicon or monocrystalline silicon with cell and module efficiencies typically in the range 10–16%. Higher

efficiencies have been achieved in the laboratory, demonstrating that the upper end of the range can be extended to $>20\%$. Although these products have demonstrated excellent stability (>25 years under intense illumination) they are not cost competitive with other forms of power generation at present in the large scale power market. This has led to much work on reducing production costs, e.g. by light trapping, which leads to the use of thinner silicon, reducing material costs. Although significant cost reductions will be achieved by market growth (economy of scale) it is generally realised that the development of thin film silicon based devices will be essential to achieve the goal of cost competitiveness with other forms of power generation.

Amorphous silicon based devices are much cheaper to manufacture compared to the mono-crystalline and multicrystalline devices but the stabilised efficiencies of commercial products remain $<10\%$, even for double junction, triple junction and micro-morph devices. A very interesting development is the HIT cell. This hybridises amorphous silicon and monocrystalline/multicrystalline silicon technologies to lower production costs and yet achieve high efficiency devices.

The III–V compounds are excellent PV materials but are extremely expensive to produce and contain either toxic or not very abundant elements. The costs can, however, be off-set by using the III–V cells in concentrator systems. They also offer advantages for space applications, improved power/weight ratios and better radiation resistances compared to silicon devices. Narrow gap III–V compounds e.g. GaSb have potential for use in TPV systems.

Excellent progress has been made in improving the efficiencies and production processes for producing thin film solar cells based on the use of CdTe and CuGaInSe₂. Although these only account for $<1\%$ of sales at present they promise significant cost reductions compared to the crystalline silicon technologies. There has, however, been continued debate over the market acceptability of CdTe and with respect to the lack of abundance of the Ga and In in CuGaInSe₂ which may limit large scale use of these materials. The results do demonstrate that polycrystalline thin films have excellent potential for making solar cells and it may be that other compound semiconductors that do not have these problems can be developed.

The future may include the development of solar cell structures that use organic materials such as dyes, semiconductor polymers and fullerenes or devices that incorporate nano-technology into their design. A most likely further development is that of tandem/multijunction devices as these more fully use the solar spectrum to generate power [196]. By using a stack of cells, wide bandgap at the top to progressively narrower energy bandgap at the bottom it is possible to minimise both thermal and transmission losses. These result in the loss of 54% of the available power in a single junction silicon solar cell. Although so far most successfully demonstrated with GaAs and GaSb cells (efficiency $>36\%$) there is particularly good potential for using the tandem concept with thin film devices.

When developing new energy technologies, it is important that they produce low levels of greenhouse gases and have a low environmental impact. As the technology develops, analysis of the processes used and identification of potential problem areas ensure that this is achieved. It has been shown in this review that environmental assessment has been carried out within the PV industry for many years and has been undertaken alongside the development of the technologies. Published work shows that PV cells and modules show low energy payback times, with most being less than 2 years. Energy ratios are also good, with the majority being over 10, which is the usual benchmark for an energy producing technology. The possible environmental hazards associated with the technologies have been identified in the various studies and are an important part of PV research. These studies have been readily accepted by the industry. The commitment of the PV industry to recycling also increases the environmental benefits.

References

- [1] D.M. Chapin, C.S. Fuller, G.L. Pearson, *Journal of Applied Physics* 25 (1954) 676.
- [2] L.D. Partain (Ed.), *Solar Cells and Their Applications*, Wiley, 1995.
- [3] M.A. Green, *Solar Cells: Operating Principles, Technology and Systems Applications*, Prentice-Hall, 1992.
- [4] S.M. Sze, *Semiconductor Devices: Physics and Technology*, second ed. Wiley, 2004.
- [5] J.J. Loferski, *Journal of Applied Physics* 27 (1956) 777.
- [6] R.H. Bube, *Photovoltaic Materials*, Imperial College Press, 1998.
- [7] M. Green, K. Emery, D.L. King, S. Igari, W. Warta, *Progress in Photovoltaics, Research and Applications* (2005) 1349–1354.
- [8] G.P. Willeke, *Proceedings of 19th European Solar Energy Conference, Paris, June 2004*, pp. 383–386.
- [9] E.L. Ralph, *Proceedings of 11th IEEE Photovoltaics Specialist Conference, 1975*, p. 315.
- [10] J. Mandelkorn, J.H. Maneck, *Proceedings of 9th IEEE Photovoltaics Specialist Conference, Silver Spring, 1972*, p. 66.
- [11] M. Green, et al., *Proceedings of 18th IEEE Photovoltaics Specialist Conference, Las Vegas, 1985*, p. 39.
- [12] M.A. Green, *Technical Digest of the International Photovoltaic Science and Engineering Conference (PVSEC)*, 1994, pp. 391–394.
- [13] J. Zhao, A. Wang, P. Altermatt, M.A. Green, *Applied Physics Letters* 66 (1995) 3628–3636.
- [14] M.A. Green, in: M.D. Archer, R. Hill (Eds.), *Clean Electricity from Photovoltaics*, Imperial College Press, 2001, pp. 149–197.
- [15] M. Ghosh, T. Bahr, A. Muller, *Proceedings of 19th European Photovoltaic Solar Energy Conference, Paris, June 2004*, pp. 560–563.
- [16] A. Eyer, A. Rauber, A. Goetzberger, *Optoelectronics* 5 (1990) 239–257.
- [17] M.D. Rosenblum, et al., *Proceedings of 29th IEEE Photovoltaics Specialists Conference, New Orleans 2002*, pp. 58–61.
- [18] R.L. Wallace, J.I. Hanoka, A. Rohatgi, G. Crotty, *Solar Energy Materials and Solar Cells* 48 (1997) 179–186.
- [19] C.R. Wronski, D.E. Carlson, in: M.D. Archer, R. Hill (Eds.), *Clean Electricity from Photovoltaics*, Imperial College Press, 2001, pp. 199–236.
- [20] S. Amiruddin, et al., *Technical Digest of the 14th International Photovoltaics Science and Engineering Conference (PVSEC-14)*, Bangkok, Thailand, 2004, pp. 111–112.
- [21] T. Baba, et al., *Proceedings of 13th European Photovoltaic Solar Energy Conference, 1995*, pp. 1708–1711.
- [22] A. Shah, et al., *14th International Photovoltaic Science and Engineering Conference (PVSEC-14)*, Bangkok, Thailand (Technical Digest), 2004, pp. 39–40.
- [23] K. Kawamoto, et al., *12th International Photovoltaic Science and Engineering Conference (PVSEC-12)*, Jeju, Korea (Technical Digest), 2001, pp. 289–290.
- [24] K. Zweibel, A. Barnett *Renewable Energy Sources for Fuels and Electricity*, Island Press, 1993, pp. 437–482.
- [25] J. Poortmans, R. Beaucarne, R.M. Mertens, *14th International Photovoltaics Science and Engineering Conference (PVSEC-14) (Technical Digest)*, Bangkok, Thailand, 2004, pp. 13–16.
- [26] J. Poortmans, J. Nijs, R. Mertens, in: M.D. Archer, R. Hill (Eds.), *Clean Electricity from Photovoltaics* (2001), pp. 91–148.
- [27] S. Gall, et al., *Proceedings of 19th European Photovoltaic Solar Energy Conference, Paris, 2004*, pp. 475–478.
- [28] G. Beaucarne, et al., *Proceedings of 19th European Photovoltaic Solar Energy Conference, Paris, 2004*, pp. 467–470.
- [29] P.J. Verlinden, et al., *14th International Photovoltaics Science and Engineering Conference (PVSEC-14) (Technical Digest)* Bangkok, Thailand, 2004, pp. 17–20.
- [30] A.R. Gobat, M.F. Lamorte, G.W. McIver, *IRE Transactions on Military Electronics* 6 (1962) 20.
- [31] Z.I. Alferov, V.M. Andreev, M.B. Kagan, Prostavov II, V.G. Trofim, *Soviet Physics – Semiconductors* 40 (1971) 2047.
- [32] P. Rappaport, *Solar Energy* 3 (1959) 8.
- [33] S. Wagner, J.L. Shay, K.J. Bachmann, E. Buehler, *Applied Physics Letters* 26 (1975) 229.
- [34] T.J. Coutts, M. Yamaguchi, in: T.J. Coutts, J.D. Meakin (Eds.), *Current Topics in Photovoltaics*, vol. 3, Academic Press, London, 1989, pp. 79–234.
- [35] I. Weinberg, C.K. Swartz, R.E. Hart Jr. *Proceedings of the 18th IEEE Photovoltaics Specialists Conference, 1985*, pp. 5344–5349.
- [36] M. Yamaguchi, et al., *Japanese Journal of Applied Physics* 23 (1984) 302–303.

- [37] A. Yamamoto, M. Yamaguchi, C. Umera, *Applied Physics Letters* 44 (1984) 611.
- [38] M. Yamaguchi, K. Ando, A. Yamamoto, C. Umera, *Applied Physics Letters* 44 (1984) 432.
- [39] K. Ando, M. Yamaguchi, A. Yamamoto, C. Umera, *Proceedings of the 18th IEEE Photovoltaics Specialists Conference*, 1985, pp. 770–775.
- [40] N.M. Pearsall, C. Goodbody, N. Robson, I. Forbes, R. Hill, *Proceedings of 21st IEEE Photovoltaics Specialist Conference*, 1990, pp. 1172–1177.
- [41] D.J. Brinker, I. Weinberg, *Proceedings of 21st IEEE Photovoltaics Specialist Conference*, 1990, pp. 1162–1171.
- [42] M. Yamaguchi, T. Hayashi, A. Ushirokawa, Y. Takahashi, M. Koubata, M. Hashimoto, H. Okazaki, T. Takamoto, M. Ura, M. Ohmori, S. Ikegami, H. Arai, T. Orii, *Proceedings of 21st IEEE Photovoltaics Specialist Conference*, 1990, pp. 1198–1202.
- [43] M.A. Green, K. Emery, D.L. King, S. Igari, W. Warta, *Progress in Photovoltaics: Research and Applications* 13 (2005) 387–392.
- [44] I. Weinberg, C.K. Swartz, R.E. Hart Jr., *Proceedings of the European Space Power Conference*, Madrid, 1989, pp. 537–542.
- [45] E.D. Jackson, *Transactions on the Use of Solar Energy* 5 (1958) 122.
- [46] J.J. Loferski, *Proceedings of the 12th IEEE Photovoltaics Specialists Conference*, 1976, p. 853.
- [47] N.A. Gokcen, J.J. Loferski, *Solar Energy Materials* 1 (24) (1979) 271.
- [48] C.H. Henry, *Journal of Applied Physics* 51 (1980) 4494.
- [49] N.P. Kim, R.M. Burgess, B.J. Stanbery, R.A. Mickelsen, J.E. Avery, R.W. McClelland, B.D. King, M.J. Boden, R.P. Gale, *Proceedings of the 20th IEEE Photovoltaics Specialists Conference* 1988, pp. 457–461.
- [50] R.P. Gale, R.W. McClelland, B.D. Dingle, J.V. Gormley, R.M. Burgess, N.P. Kim, R.A. Mickelsen, B.J. Stanbery, *Proceedings of the 21st IEEE Photovoltaics Specialists Conference*, 1990, pp. 53–57.
- [51] L.M. Fraas, J.E. Avery, *Optoelectronic Devices Technology* 5 (1990) 297–310.
- [52] J.M. Olsen, S.R. Kurtz, A.E. Kibbler, *Proceedings of the 20th IEEE Photovoltaics Specialists Conference*, 1988, p. 777.
- [53] H. Yoon, J.E. Granata, P. Herbert, R.R. King, M. Fetzer, C.P. Colter, K.M. Edmondson, D. Law, S.G. Kinsey, D.D. Krut, J.H. Ermer, M.S. Gillanders, N.H. Karam, *Progress in Photovoltaics: Research and Applications* 13 (2005) 133–139.
- [54] P.R. Sharps, M.A. Stan, D.J. Aiken, F.D. Newman, J.S. Hills, N.S. Fatemi, *Proceedings of 19th European Photovoltaic Solar Energy Conference*, 2004, pp. 3569–3574.
- [55] M. Meusel, F. Dimroth, C. Baur, G. Siefer, A.W. Bett, K. Volz-Koch, W. Stolz, G. Strobl, C. Signorini, G. Hey, *Proceedings of 19th European Photovoltaic Solar Energy Conference*, 2004, pp. 3581–3585.
- [56] F. Dimroth, C. Baur, M. Meusel, S. van Riesen, A.W. Bett, *Proceedings of the Third World Conference on Photovoltaic Energy Conversion*, 2003, 3O-D9-01.
- [57] M. Yamaguchi, T. Takamoto, A. Khan, M. Imaizumi, S. Matsuda, N.J. Ekins-Daukes, *Progress in Photovoltaics: Research and Applications* 13 (2005) 125–132.
- [58] M. Yamaguchi, T. Takamoto, K. Araki, N.J. Ekins-Daukes, *Solar Energy Materials & Solar Cells* 79 (2005) 78–85.
- [59] M. Yamaguchi, *Solar Energy Materials & Solar Cells* 75 (2003) 261–269.
- [60] H. Sugiura, C. Amano, A. Yamamoto, M. Yamaguchi, *Japan Journal of Applied Physics* 27 (1998) 269.
- [61] G.J. Conibeer, M.A. Green, *Proceedings of 19th European Photovoltaic Solar Energy Conference*, 2004, pp. 270–277.
- [62] M.A. Green, *Proceedings of the Third World Conference on Photovoltaic Energy Conversion*, 2003, 10-B13-01.
- [63] M.J. O'Neill, *Space Technology & Applications International Forum (STAIF 2004)*, Albuquerque, 2004.
- [64] R. McConnell, R. Matson, *Proceedings of 19th European Photovoltaic Solar Energy Conference*, 2004, pp. 92–96.
- [65] J.A. Carlin, M.K. Hudait, S.A. Ringel, D.M. Wilt, E.B. Clark, C.W. Leitz, M. Currie, T. Langdo, E.A. Fitzgerald, *Proceedings of the 28th IEEE Photovoltaics Specialists Conference*, 2000, pp. 1006–1011.
- [66] S.A. Ringel, C.L. Andre, M.K. Hudait, D.M. Wilt, E.B. Clark, A.J. Pitera, M.L. Lee, E.A. Fitzgerald, M. Carroll, M. Erdtmann, J.A. Carlin, B.M. Keyes, *Proceedings of the Third World Conference on Photovoltaic Energy Conversion*, 2003, 3O-D6-05.
- [67] W. Walukiewicz, J. Wu, K.M. Yu, J.W. Ager III, E.E. Haller, J. Jasinski, Z. Liliental-Weber, H. Lu, W.J. Schaff, *Proceedings of 19th European Photovoltaic Solar Energy Conference*, 2004, pp. 30–33.
- [68] C. Baur, A.W. Bett, F. Dimroth, S. van Risen, B. Kunert, M. Traversa, K. Volz W. Stolz, *Proceedings of the Third World Conference on Photovoltaic Energy Conversion*, 2003, 3P-B5-07.
- [69] C. Honsberg, O. Jani, A. Doolittle, T. Elaissa, G. Namkoong, I. Furguson, D. Nicole, A. Payne, *Proceedings of 19th European Photovoltaic Solar Energy Conference*, 2004, pp. 15–20.

- [70] R.E. Nelson, *Semiconductor Science and Technology* 18 (2003) S141–S143.
- [71] N.-P. Harder, P. Wurfel, *Semiconductor Science and Technology* 18 (2003) S151–S157.
- [72] D.C. White, H.C. Hottel, *Proceedings of the 1st NREL conference on Thermophotovoltaic Generation of Electricity (TPV1)*, 1995, pp. 425–456.
- [73] L.D. Woolf, *Solar Cells* 19 (1) (1986) 19–38.
- [74] V.M. Andreev, *Proceedings of the Fifth Conference on Thermophotovoltaic Generation of Electricity (TPV5)*, 2002, pp. 289–304.
- [75] V. Andreev, V. Khvostikov, O. Khvostikova, N. Kaluzhniy, E. Oliva, V. Rumyanstev, S. Titov, M. Shvarts, *Proceedings of the Third World Conference on Photovoltaic Energy Conversion*, 2003, 10-B7-02.
- [76] O.V. Sulima, A.W. Bett, M.G. Mauk, F. Dimroth, P.S. Dutta, R.L. Mueller, *Proceedings of the Fifth Conference on Thermophotovoltaic Generation of Electricity (TPV5)*, 2002, pp. 434–441.
- [77] M.G. Mauk, V.M. Andreev, *Semiconductor Science and Technology* (18) (2003) S191–S201.
- [78] R.J. Wehrer, M.W. Wanlass, D. Taylor, B. Wernsman, J.J. Carapella, R.W. Schultz, S.P. Ahrenkiel, D.M. Wilt, M.W. Dashiell, R.R. Siegiej, S.D. Link, R.L. Messham, *Proceedings of the 6th Thermophotovoltaic Generation of Electricity Conference (TPV6)*, (AIP 738), 2004, pp. 445–452.
- [79] L.M. Frass, R. Ballantyne, S.-Z. Ye, S. Hui, S. Gregory, J. Keyes, J. Avery, D. Lamson, B. Daniels, *Proceedings of the 4th NREL conference on Thermophotovoltaic Generation of Electricity (TPV4)*, 1999, pp. 480–487.
- [80] C. Rohr, P. Abbott, I. Ballard, J.P. Connolly, K.W.J. Barnham, L. Nasi, C. Ferrari, M. Mazzer, J.S. Roberts, *Proceedings of the Fifth Conference on Thermophotovoltaic Generation of Electricity (TPV5)*, 2002, pp. 344–353.
- [81] D.M. Wilt, N.S. Fatemi, R.W. Hoffman Jr., P.P. Jenkins, D. Scheiman, R. Lowe, G.A. Landis, *Proceedings of the 1st NREL Thermophotovoltaic Generation of Electricity Conference (TPV1)*, (AIP 321), 1994, pp. 210–220.
- [82] D. Wilt, R. Wehrer, M. Palmisiano, M. Wanlass, C. Murray, *Semiconductor Science and Technology* 18 (2003) S209–S215.
- [83] S.L. Murray, C.S. Murray, F.D. Newman, M.V. Turner, R.R. Siegiej, R. Wehrer, B. Wernsman, R.G. Mahorteer, S.P. Ahrenkiel, M.W. Wanlass, *Proceedings of 19th European Photovoltaic Solar Energy Conference*, 2004, pp. 97–100.
- [84] J.S. Ward, A. Duda, M.W. Wanlass, J.J. Carapella, X. Wu, R.J. Matson, T.J. Coutts, T. Moriarty, C.S. Murray, D.R. Riley, *Proceedings of the 3rd NREL conference on Thermophotovoltaic Generation of Electricity (TPV3)*, 1997, p. 227.
- [85] R.R. Siegiej, S. Sinharoy, T. Valko, R.J. Wehrer, B. Wernsman, S.D. Link, R.W. Schultz, R.L. Messham, *Proceedings of the 6th Conference on Thermophotovoltaic Generation of Electricity (TPV6)*, 2004, pp. 480–488.
- [86] S.L. Murray, C.S. Murray, F.D. Newman, M.V. Turner, R.R. Siegiej, R. Wehrer, B. Wernsman, R.G. Mahorter, S.P. Ahrenkiel, M.W. Wanlass, *Proceedings of 19th European Photovoltaic Solar Energy Conference*, 2004, pp. 97–100.
- [87] V.M. Andreev, V.A. Grilikhes, V.P. Khvostikov, O.A. Khvostikova, V.D. Rumyanstev, N.A. Sadchikov, M.Z. Shvarts, *Solar Energy Materials & Solar Cells* 84 (2004) 3–17.
- [88] K.W.J. Barnham, P. Abbott, I. Ballard, D.B. Bushnell, J.P. Connolly, N.J. Ekins-Daukes, M. Mazzer, J. Nelson, C. Rohr, T.N.D. Tibbits, R. Airey, G. Hill, J.S. Roberts, *Proceedings of the Third World Conference on Photovoltaic Energy Conversion*, 2003, 30-D6-04.
- [89] A. Martí, A. Luque, C. Stanley, T. Dittrich, P. Wahnón, C. Tablero, R. Bayón, N. López, L. Cuadra, D. Zhou, J.L. Pearson, A. McKee, A. Belaidi, Y. Milovanov, T. Guminskaya, J.J. Fernández, P. Palacios, J. Alonso, *Proceedings of 19th European Photovoltaic Solar Energy Conference*, 2004, pp. 9–14.
- [90] M.A. Green, *Proceedings of 19th European Photovoltaic Solar Energy Conference*, 2004, pp. 3–8.
- [91] D.A. Cusano, *Solid State Electronics* 6 (1963) 217.
- [92] E.I. Adriorvich, Y.M. Yuanov, G.R. Yadudaev, *Soviet Physics – Semiconductors* 3 (1969) 61.
- [93] D. Bonnet, H. Rabenhorst, *Proceedings of the 9th IEEE Photovoltaics Specialists Conference*, 1972, pp. 129–131.
- [94] T.L. Chu, et al., *Proceedings of the 11th European Photovoltaic Specialist Conference*, Montreux 1992, pp. 988–990.
- [95] D. Bonnet, *Proceedings of 19th European Photovoltaic, Solar Energy Conference*, Paris, 2004, pp. 1657–1662.
- [96] D. Rose, R. Powell, U. Jayamaha, Maltby, *Proceedings of the 29th IEEE Photovoltaics Specialists Conference*, New Orleans, 2002, pp. 555–558.
- [97] D. Bonnet, in: M.D. Archer, R. Hill (Eds.), *Clean Electricity from Photovoltaics*, Imperial College Press, 2001, pp. 245–275.
- [98] D.W. Cunningham, et al., *Proceedings of 29th IEEE Photovoltaics Specialist Conference*, New Orleans, 2002, pp. 559–561.

- [99] T. Nishio, Proceedings of 25th IEEE Photovoltaic Specialist Conference, Washington, 1996, pp. 953–956.
- [100] R. Wendt, A. Fischer, D. Grecu, A.D. Compaan, Journal of Applied Physics 84 (5) (1998) 2920–2925.
- [101] R.W. Miles, et al., Journal of Materials Science and Engineering B16 (1993) 250.
- [102] X. Wu, et al., Proceedings of the 29th IEEE Photovoltaics Specialists Conference, New Orleans, 2002, pp. 531–534.
- [103] Fritsche, et al., Thin Solid Films 403–404 (2002) 252–257.
- [104] R.W. Miles, et al., in: V. Stefan, E.V. Zharikov (Eds.), Frontiers in Science and Technology, vol. 2, Stefan University Press, La Jolla, California, 2002, pp. 107–140.
- [105] S. Wagner, J. Shay, P. Migliorato, H.M. Kasper, Applied Physics Letters 25 (1974) 434.
- [106] L.L. Kazmerski, et al., Applied Physics Letters 46 (1976) 268.
- [107] K. Ramanathan, et al., Progress in Photovoltaics: Research and Applications 11 (2003) 225–230.
- [108] K. Siemer, et al., Proceedings of 16th European Photovoltaic Solar Energy Conference, Glasgow, pp. 895–898.
- [109] U. Rau, H.W. Schock, in: M.D. Archer, R. Hill (Eds.), Clean Electricity from Photovoltaics, Imperial College Press, 2001, pp. 277–332.
- [110] A. Mickelson, W.S. Chen, Proceedings of 15th IEEE Photovoltaics Specialist Conference, 1981, p. 800.
- [111] M. Powella, D. Dimmler, Proceedings of 17th European Photovoltaic Solar Energy Conference, Munich, 2002, pp. 983–988.
- [112] B.M. Basol, V.J. Kapur, IEEE Transactions on Electronic Devices 37 (1990) 418.
- [113] M.J. Carter, et al., Proceedings Of 19th IEEE Photovoltaics Specialist Conference, New Orleans, 1987, p. 1275.
- [114] H.S. Ullal, K. Zweibal, B. von Roedern, Proceedings of 29th IEEE Photovoltaics Specialist Conference, New Orleans, 2002, pp. 472–477.
- [115] H.S. Ullal, Proceedings of 19th European Photovoltaic, Solar Energy Conference, Paris, 2004, pp. 1678–1681.
- [116] V. Probst, et al., 17th European Photovoltaic specialist Conference, Munich, 2002, pp. 1005–1010.
- [117] A.E. Delahoy, et al., Proceedings of 29th IEEE Photovoltaics Specialist Conference, New Orleans, 2002, pp. 640–643.
- [118] T. Minemoto, et al., Proceedings of 16th European Photovoltaic Solar Energy Conference, Glasgow, 2000, pp. 686–689.
- [119] W.N. Shafarman, et al., Proceedings of 29th IEEE Photovoltaics Specialist Conference, New Orleans, 2002, pp. 519–522.
- [120] H. Katagiri, J. Kazao, M. Katsushita, and T. Kazuguki, Proceedings of 3rd World Energy Conference on Photovoltaic Energy Conversion (WEPV3), Osaka, Japan, 2003, paper S40/C12/03.
- [121] F. Adorodija, I. Forbes, M.J. Carter, R. Hill, Journal of Materials Science Letters 15 (1996) 478–481.
- [122] R.W. Miles, I. Forbes, K.T. Ramakrishna Reddy, D. Johnston, D.W. Lane, K.D. Rogers, A. Chapman, Journal of Materials Science (Materials in Electronics) 14 (9) (2003) 567–571.
- [123] I. Forbes, K.M. Hynes, D. Johnston, R.W. Miles, D.W. Lane, J.D. Painter, K.D. Rogers, Proceedings of 18th European Photovoltaic Solar Energy Conference, Paris, June, 2004, pp. 1939–1942.
- [124] S. Armstrong, P.K. Datta, R.W. Miles, Thin Solid Films 403–404 (2002) 126–129.
- [125] K.T.R. Reddy, Y.P.V. Subbaiah, T.B. Reddy, R.W. Miles, Proceedings of 14th International Photovoltaics Science and Engineering Conference (PVSEC-14), (Technical Digest), Bangkok, Thailand, 2004, pp. 699–700.
- [126] A. Hinsch, et al., Proceedings of the 17th European Photovoltaic Solar Energy Conference, Munich, 22–26 October 2001, pp. 995–1000.
- [127] B. O'Regan, M. Gratzel, Nature 235 (1991) 737–740.
- [128] M. Gratzel, Progress in Photovoltaics 8 (2000) 171–186.
- [129] M. Gratzel, MRS Bulletin 30 (1) (Jan 2005) 23–27.
- [130] J.M.H. Halls, R. Friend, in: M.D. Archer, R. Hill (Eds.), Clean Electricity from Photovoltaics, Imperial College Press, 2001, pp. 377–445.
- [131] R.A.J. Janssen, J.C. Hummelen, N.S. Sariciftci, MRS Bulletin 30 (1) (Jan 2005) 33–36.
- [132] S.R. Forrest, MRS Bulletin 30 (1) (Jan 2005) 28–32.
- [133] S.E. Shaheen, D.S. Girley, G.E. Jabbour, MRS Bulletin 30 (1) (Jan 2005) 10–19; MRS Bulletin 30 (1) (Jan 2005) 20–22.
- [134] K.M. Coakley, Y. Lii, G. Chiatzun, M.D. McGehee, MRS Bulletin 30 (1) (Jan 2005) 37–40.
- [135] D.J. Million, I. Gur, P. Alivisatos, MRS Bulletin 30 (1) (Jan 2005) 41–44.
- [136] G.G. Wallace, C.O. Too, D.L. Officer, P.C. Dastoor, MRS Bulletin 30 (1) (Jan 2005) 46–49.
- [137] C.J. Brabec, J.A. Hauch, P. Schilinsky, C. Waldauf, MRS Bulletin 30 (1) (Jan 2005) 50–52.
- [138] I. Boustead, G.F. Hancock, Handbook of Industrial Energy Analysis, Ellis Horwood Publishers, Chichester, UK, 1979.

- [139] L.P. Hunt, Proceedings of the 12th IEEE Photovoltaic Specialists Conference, Louisiana, USA, 1976, pp. 347–52.
- [140] J. Lindmeyer, Report No. SX/111/1Q (ERDA/JPL 954606 77/1), Solarex Corporation, Rockville, USA, 1977.
- [141] H. Fischer, Proceedings of the 1st EC Photovoltaic Solar Energy Conference, Luxembourg, 1977, pp. 52–75.
- [142] M. Wolf, H.M. Goldman, A.C. Lawson, Proceedings of the 13th IEEE Photovoltaic Specialists Conference, Washington, USA, 1978, pp. 271–280.
- [143] P. Iles, Proceedings of the Symposium on the Material Science Aspect of Thin Solid Films for Solar Energy Conversion, 1974.
- [144] K. Hay, J.D.L. Harrison, R. Hill, T. Riaz, Proceedings of the 15th IEEE Photovoltaic Specialists Conference, Kissimmee, USA, 1981, pp. 267–272.
- [145] F. Riddoch, J.I.B. Wilson, *Solar Cells* 2 (1980) 141.
- [146] G. Jenkins, R. Harrison, WESC E/5A/CON/1632/172/099, Final Report, Section 2, 1981.
- [147] W.H. Bloss, W. Arndt, G. Bilger, G.H. Hewig, P. Pfisterer, H.W. Schock, Proceedings of the ISES Silver Jubilee, Atlanta, USA, 1979.
- [148] K.M. Hynes, N.M. Pearsall, R. Hill, Proceedings of the 10th EC Photovoltaic Solar Energy Conference, Lisbon, Portugal, 1991, pp. 461–464.
- [149] K.M. Hynes, A.E. Baumann, R. Hill, Proceedings of the 1st World Conference on Photovoltaic Energy Conversion, Hawaii, USA, 1994, pp. 958–961.
- [150] G. Hagedorn, Proceedings of the 9th EC Photovoltaic Solar Energy Conference, Freiburg, Germany, 1989, pp. 542–545.
- [151] W. Palz, H. Zibetta, *International Journal of Solar Energy* 10 (3–4) (1991) 211–216.
- [152] E.A. Alsema, *Renewable and Sustainable Energy Reviews* 2 (1998) 387–415.
- [153] E.A. Alsema, Report no. 96074, ISBN 90-73958-17-2, 1996.
- [154] E.A. Alsema, P. Frankl, K. Kato, Proceedings of the 2nd World Conference and Exhibition on Photovoltaic Solar Energy Conversion, Vienna, Austria, 1998, pp. 2125–2130.
- [155] E.A. Alsema, M.J. de Wild-Scholten, Proceedings of the 19th European Photovoltaic Solar Energy Conference, Paris, France, 2004, pp. 840–843.
- [156] E.A. Alsema, M.J. de Wild-Scholten, Proceedings of the 20th European Photovoltaic Solar Energy Conference, Barcelona, Spain, in press.
- [157] K.E. Knapp, T.L. Jester, Proceedings of the 16th European Photovoltaic Solar Energy Conference, Glasgow, 2000, pp. 2053–2056.
- [158] P.N.K. Deenapanray, A.W. Blakers, K.J. Weber, V. Everen, Proceedings of the 19th European Photovoltaic Solar Energy Conference, Paris, France, 2004, pp. 1233–1236.
- [159] G. Peharz, F. Dimroth, *Progress in Photovoltaics: Research and Applications*, in press.
- [160] M. Raugei, S. Bargigli, S. Ulgiati, Proceedings of the 20th European Photovoltaic Solar Energy Conference, Barcelona, in press.
- [161] K.M. Hynes, N.M. Pearsall, M. Shaw, F.J. Crick, Proceedings of the 13th European Photovoltaic Solar Energy Conference, Nice, France, 1995, pp. 2202–2205.
- [162] K. Kato, A. Murata, K. Sakuta, *Progress in Photovoltaics: Research and Applications* 6 (1998) 105–115.
- [163] O. Hohmeyer, R.L. Ottinger (Eds.), Proceedings of a German–American Workshop, Ladenburg, FRG, 1990.
- [164] R.L. Ottinger, D.R. Wooley, N.A. Robinson, D.R. Hodas, S.E. Babb, *Environmental Costs of Electricity*, Oceana Publications Inc, New York, USA, 1991.
- [165] B. Sorensen, Life-cycle assessment of energy systems. Report prepared for OECD, 1992.
- [166] B. Sorensen, Proceedings of the 2nd World Conference and Exhibition on Photovoltaic Solar Energy Conversion, Vienna, Austria, 1998, pp. 3461–3464.
- [167] M.J. de Wild-Scholten, E.A. Alsema, Proceedings of the Workshop on Life-Cycle Analysis and Recycling of Solar Modules – “The Waste Challenge”, Brussels, 2004, pp. 113–124.
- [168] R. Friedrich, Proceedings of the Workshop on Life-Cycle Analysis and Recycling of Solar Modules – “The Waste Challenge”, Brussels, 2004, pp. 125–138.
- [169] A.E. Baumann, R. Ferguson, I. Fells, R. Hill, Proceedings of the 10th EC Photovoltaic Solar Energy Conference, Lisbon, Portugal, 1991, pp. 834–837.
- [170] Workshop on Life-Cycle Analysis and Recycling of Solar Modules – “The Waste Challenge”. Brussels, March 2004.
- [171] E.A. Alsema, van Engelenberg, Proceedings of the 11th European Photovoltaic Solar Energy Conference, Montreux, 1992, pp. 995–998.
- [172] B.C.W. van Engelenberg, E.A. Alsema, Proceedings of the 12th European Photovoltaic Solar Energy Conference, Amsterdam, 1994, pp. 305–308.

- [173] K.M. Hynes, A.E. Baumann, R. Hill, Proceedings of the 12th European Photovoltaic Solar Energy Conference, Amsterdam, 1994, pp. 309–312.
- [174] G.J.M. Phylipsen, E.A. Alsema, Environmental life-cycle assessment of multicrystalline silicon solar cell modules. Report no. 95057. NOVEM, 1995.
- [175] P. Frankl, A. Corrado, Lombardelli, Proceedings of the 19th European Photovoltaic Solar Energy Conference, Paris, 2004, pp. 3373–3376.
- [176] V.M. Fthenakis, E.A. Alsema, M.J. de Wild-Scholten, Proceedings of the 31st IEEE Photovoltaic Specialists Conference, Orlando, 2005, pp. 1655–1657.
- [177] Progress in Photovoltaics: Research and Application 6 (1998) 87–146.
- [178] V.M. Fthenakis, P.D. Moskowitz, Progress in Photovoltaics: Research and Applications 3 (1995) 295–306.
- [179] K.M. Hynes, I. Forbes, R.W. Miles, J.D. Painter, D.W. Lane, K.D. Rogers, Proceedings of the 19th European Photovoltaic Solar Energy Conference, Paris, 2004, pp. 2529–2532.
- [180] K.M. Hynes, J. Newham, Proceedings of the 16th European Photovoltaic Solar Energy Conference, Glasgow, 2000, pp. 2297–2300.
- [181] A.E. Baumann, K.M. Hynes, J. Herrero, Proceedings of the 2nd World Conference and Exhibition on Photovoltaic Solar Energy Conversion, Vienna, 1998, pp. 735–738.
- [182] H. Steinberger, Proceedings of the 2nd World Conference and Exhibition on Photovoltaic Solar Energy Conversion, Vienna, 1998, pp. 2276–2278.
- [183] V.M. Fthenakis, Proceedings of the 19th European Photovoltaic Solar Energy Conference, Paris, 2004, pp. 2166–2169.
- [184] E.A. Alsema, A.E. Baumann, R. Hill, M.H. Patterson, Proceedings of the 14th European Photovoltaic Solar Energy Conference, Barcelona, 1997, pp. 1505–1508.
- [185] A. Meijer, M.A.J. Huijbregts, J.J. Schermer, L. Reijnders, Progress in Photovoltaics: Research and Applications 11 (2003) 275–287.
- [186] K. Wambach, Proceedings of the 19th European Photovoltaic Solar Energy Conference, Paris, 2004, pp. 2018–2023.
- [187] K. Wambach, Proceedings of the 19th European Photovoltaic Solar Energy Conference, Paris, 2004, pp. 572–575.
- [188] L. Frisson, K. Lieten, T. Bruton, K. Declercq, J. Szlufcik, H. De Moor, Proceedings of the 16th European Photovoltaic Solar Energy Conference, Glasgow, 2000, pp. 2160–2163.
- [189] J. Bohland, T. Dapkus, K. Kamm, K. Smigielski, Proceedings of the 2nd World Conference and Exhibition on Photovoltaic Solar Energy Conversion, Vienna, 1998, pp. 716–719.
- [190] R.E. Goozner, W.F. Drinkard, M.O. Long, C.M. Byrd, Proceedings of the 26th IEEE Photovoltaic Specialists Conference, Anaheim, 1997, pp. 1161–1163.
- [191] C. Eberspacher, C.F. Gay, Proceedings of the 1st World Conference on Photovoltaic Energy Conversion, Hawaii, 1994, pp. 962–965.
- [192] S. Menezes, Proceedings of the 2nd World Conference and Exhibition on Photovoltaic Solar Energy Conversion, Vienna, 1998, pp. 597–600.
- [193] B. Malinowska, M. Rakib, G. Durand, Proceedings of the 19th European Photovoltaic Solar Energy Conference, Paris, 2004, pp. 1820–1823.
- [194] N.G. Dhere, S.S. Kulkarni, A.A. Kadam, Proceedings of the 19th European Photovoltaic Solar Energy Conference, Paris, 2004, pp. 1966–1968.
- [195] V.M. Fthenakis, Energy Policy 28 (2000) 1051–1058.
- [196] M.A. Green, Proceedings of 19th European Photovoltaic Solar Energy Conference, Paris, June 2004, pp. 3–8.



Dr. Robert Miles was born in Sedgfield, Co. Durham, UK in 1952. He was educated at Imperial College, London during the 1970s where he obtained an honours degree in Physics (BSc ARCS) a Masters in the Science of Materials (MSc DIC) and a Doctorate in Science (PhD). His research interests include the development of thin film photovoltaic solar cells based on the use of the II-VI and chalcopyrite compounds, infrared detectors based on the use of mercury cadmium telluride and gas sensor devices based on the use of semiconductor polymers. He is currently a Reader at the University of Northumbria Newcastle where he also leads the postgraduate teaching programmes in Optoelectronic, Microelectronic and Communications Engineering. He is a Member of the Institute of Physics, the European Materials Research Society, PV-Net, the EPSRC College and the Editorial Advisory Board of Vacuum.



Kathleen Hynes was born in Northumberland, United Kingdom in 1958. She gained a BSc (Hons) in Social and Physical Sciences in 1979 and an MPhil in physics and economics in 1982 from Northumbria University, UK (formerly Newcastle Polytechnic). She is currently a research associate in the Northumbria Photovoltaics Applications Centre at Northumbria University, UK and has responsibility for the environmental assessment of various thin film PV cell technologies.

She has worked in PV research for over 20 years and has experience of research in a range of aspects of photovoltaics such as techno-economic studies, energy analysis, environmental assessment and testing, and system monitoring and performance analysis. A variety of UK and European funded projects have been undertaken with over 30 research institutes throughout the UK and Europe. She has published over 30 papers in scientific journals and conference proceedings.



Ian Forbes was born in Devon in 1959. He gained an honours degree in Materials Technology from the University of Surrey in 1983. After working on optical fibres for GEC during the mid eighties he obtained a post graduate diploma in optoelectronics from Newcastle Polytechnic. He then worked at the Northumbria Photovoltaics Applications Centre (NPAC) on MOD and EPSRC—LINK funded research projects into ITO/InP solar cells for space applications. He was awarded his PhD in 1993 by the University of Northumbria. His research interests include thermophotovoltaics (TPV), device characterisation and thin film photovoltaic (PV) materials and devices based on the chalcopyrite materials system. He is currently the Operations Manager of the PV Cell Test Facility and is the principal investigator on the PV21 SUPERGEN programme at Northumbria.